



Swim-crete
POOL PRODUCTS

A revolution in pool construction...



- **Customer-Oriented**
- **Competitive Prices**
- **Top Quality Products**
- **Superior Technical Support**
- **Making Your Job Faster and Easier**



Swim-crete™ Pool Products has been the leader in custom designed pool forms since 1980. As a division of Wall-Ties & Forms, Inc., one of the largest aluminum concrete form manufacturers, Swim-crete has served pool dealers all over the United States and throughout the world. With over one hundred-fifty employees in our 100,000 square foot, state-of-the-art facility located in suburban Kansas City, we pride ourselves in offering the best customer service, the highest quality forming systems, and the most extensive product line available.

After many years of product engineering, evaluation, consultation with installers, and on-site inspections, Swim-crete Pool Products continues to revolutionize the industry in vinyl liner and all-concrete pool construction. Our staff at Swim-crete is ready to explain the simplicity of the system and show you how unskilled labor and readily available materials can cut costs and building time while giving your customer a better product. We know you will be impressed by the ease of construction utilizing the Swim-crete system as well as the number of possible configurations available. Additionally Swim-crete aluminum forms are so durable they typically last for 2,000 uses or more.



Swim-crete Pool Products • 4000 Bonner Industrial Drive • Shawnee, KS 66226 USA
Tel: (800) 444-9692 • (913) 441-0073 • Fax: (913) 441-0076

www.swimcrete.com

Table of Contents

<u>Introduction</u>	2-6	<u>Pouring Shovel</u>	38
<u>Construction Process</u>	7-24	<u>Slide Hammer</u>	39
<u>Forming Basics</u>	8-10	<u>Parapet Bracket</u>	39
<u>Vinyl Liner</u>	11-17	<u>Hottub & Step Parapet Brackets</u>	40
<u>All-Concrete Pool Construction</u>	18-24	<u>5 Gallon Spray Tanks</u>	41
<u>The Forms</u>	25-34	<u>Pouring Board</u>	41
<u>Straight Wall Forms</u>	27	<u>Standard Chute w/Flare</u>	41
<u>Radius Forms</u>	28	<u>Crete-Lease 727 Release Agent</u>	42
<u>Corner Forms</u>	29	<u>Crete-Lease "Break In"</u>	42
<u>Skimmer/Pilaster Forms</u>	30	<u>Step Shapes</u>	43-48
<u>Swimout/Bench Forms</u>	31	<u>Pool Shapes</u>	49-60
<u>Secondary Pour Bullnose Coping Forms</u>	32	<u>Spa/Hottub Shapes</u>	61-62
<u>Stackable Raised Wall Forms</u>	32	<u>Aluma-Trac</u>	63-67
<u>Overflow Forms & Channel</u>	33	<u>CAD Design Services</u>	68
<u>Offset Forms</u>	34	<u>Marketing Services</u>	69-70
<u>Essential Extras</u>	35-42	<u>Financial Services</u>	71
<u>Adjustable Waler Bracket/Waler Board</u>	36	<u>Credit Application</u>	73-74
<u>Standard Pin & Wedge</u>	36		
<u>Standard Wall Ties</u>	37		
<u>Blockoffs</u>	37		
<u>Leveling System</u>	38		
<u>Aluminum Wall Brace</u>	38		
<u>Turnbuckles</u>	38		
<u>Tie Twister</u>	38		



What makes Swim-crete™ aluminum forms the best forming system in the pool industry?

At Swim-crete™ Pool Products we utilize advanced robotics, fiber optics, and the latest in computer technology to produce the best quality product at a competitive price.

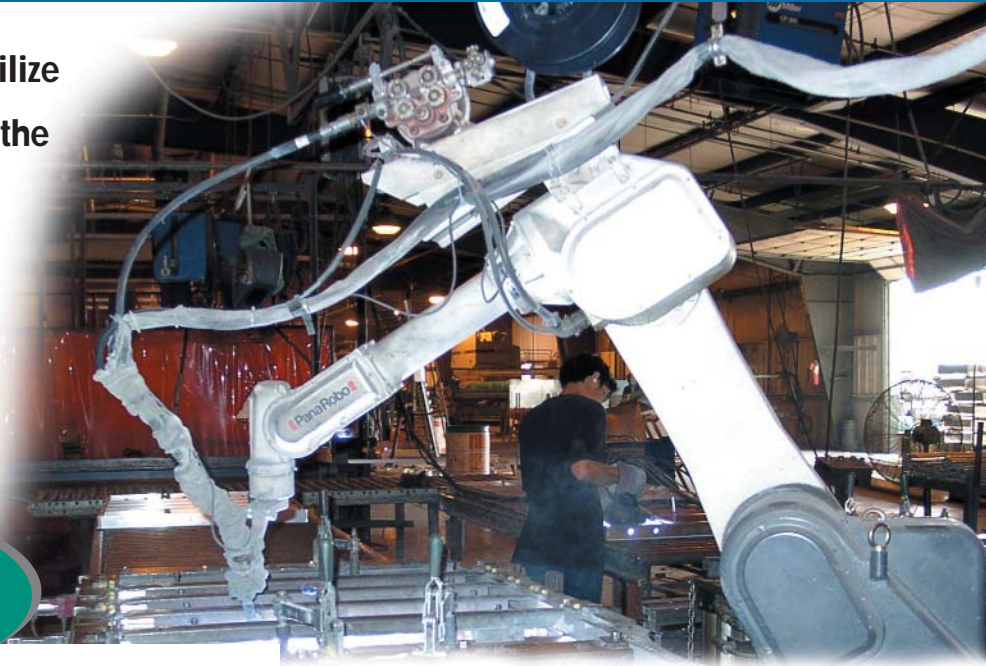

Our forms continue to revolutionize the pool industry!



Innovative Designs



Kimberlane Pools
Athens, GA

A Swim-crete representative on-site for customer first time pool form setup.*
(ask for details)

Prestige Pools
Raleigh, NC

Four reasons Pool Dealers have found our pool systems to be the best on the market...



Randy Rodecker and Pat Spratt of Swim King Pools
Long Island, NY



Dear Swim-crete,

The Swim-Crete Pool System Forms that I purchased have given me a great deal of latitude in design offerings for my customers as well as ease in handling for my workers. They are lighter weight and more manageable to load, transport and set up at the job sites.

Although the initial investment is high, they are cost effective over the long run in providing an array of shapes and designs I can offer customers, the set up and dismantling time is shortened and they allow me to produce a top quality concrete wall vinyl lined pool quickly.

My construction process and production time have been positively affected by using the Swim-Crete Pool System. That's a businessman's goal.

Sincerely,

Randy Rodecker
Randy T. Rodecker



1. Cost Savings

Cost savings are two-fold.

The first cost savings is eliminating expensive pool kits that are left behind time after time. In addition, when utilizing the Swim-crete pool system for all-concrete pool construction, it eliminates much of the labor intensive construction process.

Secondly, unskilled labor is easily trained to utilize the system, whether constructing a vinyl liner or all-concrete pool.



Skordis Hydrodynamics, Ltd.
Paphos, Cyprus



Secure Pools
Raytown, MO

**Consider the quality...
It's the impression you leave**

"I am a pool builder in the Raleigh, NC area and I have been in the pool business since 1984. Two of the things I look for in my business is a way to give my customer a better product than they can get anywhere else, and secondly, a way to set myself apart from the local competition.



I am so fortunate to have responded to the email last year from Swim-crete. They were extremely helpful from the very beginning as were their existing customers that I spoke with and visited. They walked me through everything and helped me install two pools. I also worked with the marketing department. They made a nice two page brochure that I am using as a newspaper insert. The cost was very reasonable. From my first contact, to now, I feel that Swim-crete has gone out of their way to make sure that my business is better than it was before. I look more professional and I build a better pool. Please, if you live out of my market area contact me, I will be glad to help!"

Keith Cowell
Prestige Pools - Raleigh, NC

**Higher Profits
with greater
versatility!**



Holiday Pools
Eugene, OR

2. Simplicity



The Swim-crete system allows unskilled labor to be quickly trained in the use of the forming equipment. This is achieved by utilizing lightweight, high strength aluminum in the manufacture of the forms. This makes the modular system man portable and easy to assemble without the need of additional equipment.

Watco, Inc.
Billings, MT

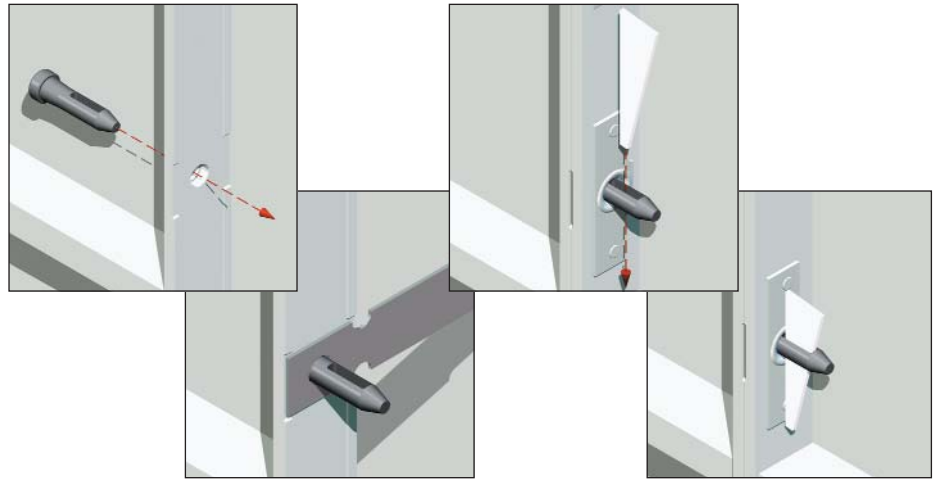

In addition, a simple Tie, Pin, and Wedge system is used to set the forms.

3. Longevity/Minimal Maintenance

Daily, Swim-crete forming systems are used around the world. With minimal maintenance, pool dealers have found that they get 2,000 or more uses with our forming system. This is achieved by using lightweight high grade aluminum, in addition to advanced robotics, fiber optics, and the latest in computer technology in the manufacturing process.

4. Higher Profits

Our pool dealers have found they achieve greater margins because of the many inherent advantages of concrete. These include quality, strength, durability and flexibility. Pool dealers have realized additional profits generated by using the Swim-crete step system as an upgrade to their customers. This practice often pays for the entire forming system.



American Pools
Hayesville, KS

Construction Process



Swim-crete pool systems are versatile enough to be used in Vinyl Liner and All-Concrete Pool Construction.



Forming Basics

Skimmers

Method 1 - Pour in place

Dedicate an interior concrete form, screw holes in face sheet for skimmer, and use a pilaster form on exterior wall. Add short section of pipe with coupling to skimmer. Coupling should be taped and fit securely against pilaster form.

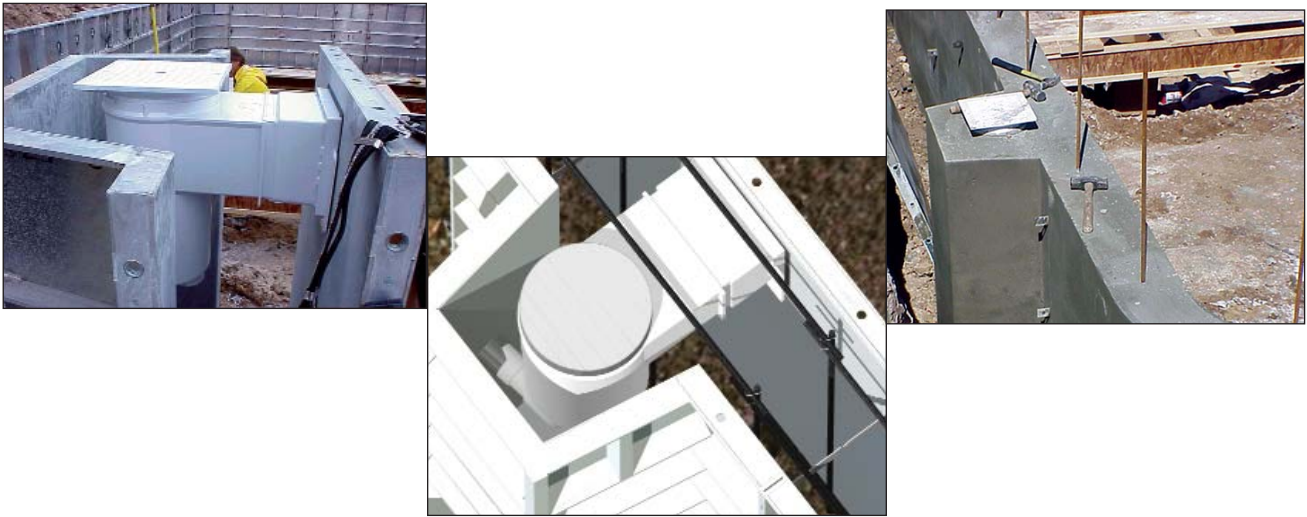

Method 2 - Block out

Simply block out an area to desired dimension using wood or a prefabricated concrete form block out. After forms are removed, place skimmer in wall and finish installation using mortar.



Method 1 - Pour in place

Simply screw a standard inlet head directly to interior panel.

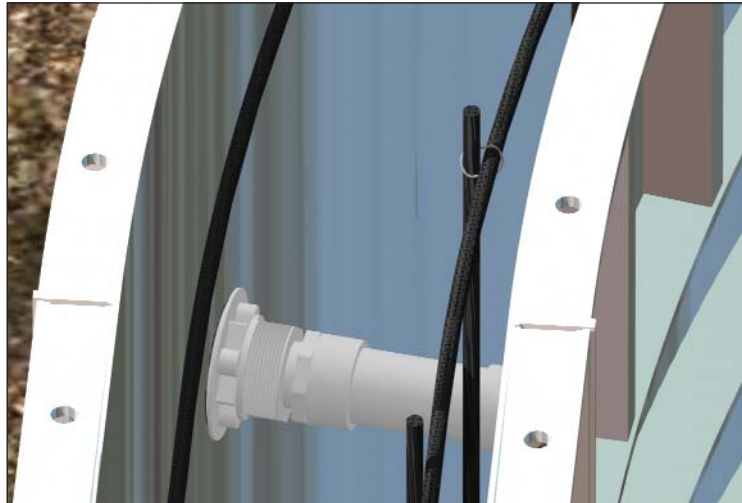

Method 2 - Block out

Simply block out with a 4" piece of PVC pipe. Once forms are removed fill PVC pipe with mortar and push inlet head with plumbing extension of at least 11" through pipe (be sure both ends of inlet fixture are taped). Then trowel to a smooth finish as seen below.



Light Installation

Using screws attach the light fixture to the face sheet of the interior form. Cut a piece of PVC pipe to fit securely between the light fixture and exterior form. Tape all plumbing and light conduits to eliminate concrete leakage.



Cascading/Shear Wall Fountains

In much the same fashion as other swimming pool white goods and lighting, cascading/shear wall fountains can be installed utilizing the block out method or the pour in place method.



Vinyl Liner Pool Construction

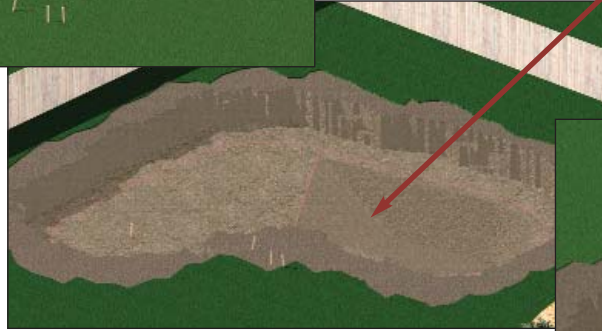
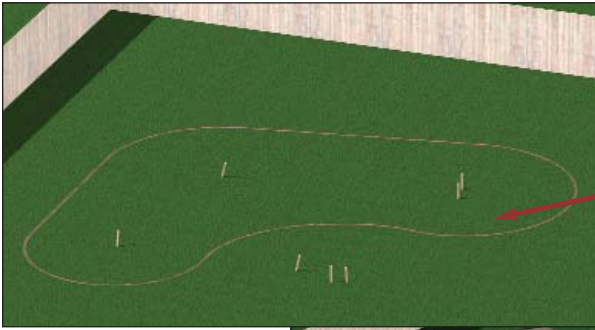

- Lay pool shape out
- Excavate pool & hopper
- Chalk lines for interior pool panels



Excavation

Commonly an inside 6" lip is part of the over dig. The purpose of this lip is to allow working room for setting of forms. Once forms are set and concrete placed, cut this lip away when shaping the hopper. Also, the working shelf should be as level as possible for the setting of the concrete forms.



The excavated depth of the hopper should be 9" to 12" deeper than the specified finished depth to compensate for the material used for surfacing the bottom and hole shaping.

Setting Forms

Once the shelf is prepared, lay out forms, both inside and outside. Utilizing the Swim-crete pool prints, start with the step forms. Step forms should be set and level prior to setting any wall forms. When step forming is complete, begin setting wall. Walls can be set from both sides of the step system to enable closing of forms at opposite end of pool.



Steps - Concrete

Steps should always be set first when utilizing the Swim-crete concrete step system. Refer to step prints for form placement of the particular step design you are utilizing.

Steps - Fiberglass

Fiberglass steps may also be used with the Swim-crete system. If using a fiberglass step kit, use two C.C.A. treated 2x10's with lag bolts or use Swim-crete special ties to secure step system to lumber, ensuring bolts protrude into space that will be poured in concrete. This will allow for anchoring into concrete wall.



Other fiberglass items, such as swimouts/benches are installed in a similar manner.



Squaring & Leveling

Using the dimensions from the Swim-crete prints, square the pool.

Then level using the Swim-crete Leveling System and a laser, transit or water level.

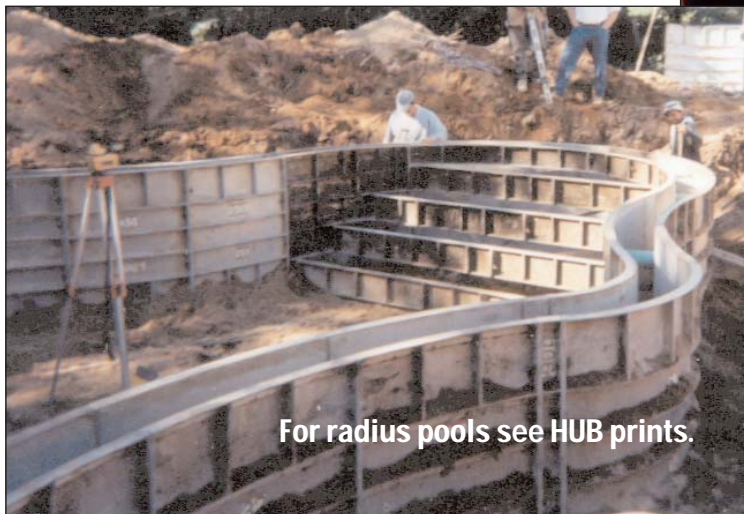

For radius pools see HUB prints.



Placing Concrete

After the form system is level and square, check all inlet fittings, skimmers, light housing and tie placement to ensure they are secured properly. Then concrete is ready to be placed. Recommended concrete is a minimum of 3,000 psi, 3" slump mix for steps. Once concrete steps are poured, increase concrete slump to desired flowability for wall area. For concrete yardage refer to Swim-crete pool prints.



Form Removal

Once concrete has achieved minimum required strength (typically the morning after concrete placement), the forms can be removed. When utilizing radius forms, form removal begins at an outside radius or straight wall form.



Note: Remove all screws from forms where white goods are located prior to stripping forms.

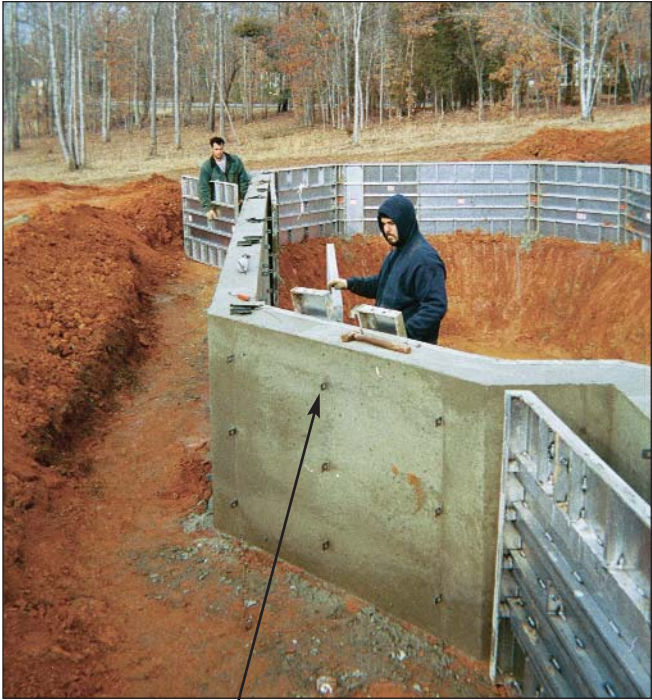

The exposed tie ends are easily broken off using a standard hammer or the Swim-crete Tie Breaker Bar.



Wall Foam

While Swim-crete aluminum forming system pours a smooth wall with minimal seams, it is recommended to foam the walls to protect the vinyl liner from unnecessary wear. When the Swim-crete step system is incorporated into the pool it is also recommended to apply foam, if it is to be vinyl lined. Using spray adhesive, spray the walls and then attach the foam. Shape and smooth bottom of pool, eliminating any ledge that may be left where pool wall and floor meet.



Track/Vinyl Liner Installation

Swim-crete recommends using Aluma-Trac liner track (aluminum track). This can be installed by drilling into the top of the wall using a standard hammer drill and attaching with stainless steel concrete screws, or by simply nailing the track on the day after the finished pour with concrete nails. If using a plastic track retainer, it can be poured in place and the track attached to it.



Install vinyl liner per manufacturer's directions.



All-Concrete Pool Construction

Excavation

Excavate the pool area to the desired shape, making sure to leave a level lip for the setting of exterior forms.



Exterior Forming

The setting of the all-concrete pool starts with the exterior concrete forms. All the exterior forms are set starting at the step (when applicable).



Exterior Forming (continued)



Steel Placement

After the exterior concrete forms are set and leveled, steel should be placed in a grid following local codes.



Interior Forming

Once exterior forms, steel reinforcement, and plumbing are in place, the interior forms are set. Interior forms are suspended using the Swim-crete parapet bracket.



Parapet Bracket

Note: Minimal or no interior bracing required to suspend interior concrete forms.

Squaring & Leveling

Using the dimensions from the Swim-crete prints, square the pool. Then level using the Swim-crete Leveling System and a laser, transit or water level.



Concrete Placement

Once all forms, steel reinforcement, and plumbing are in place, the Swim-crete system is ready for concrete placement.



3" (8 cm) slump recommended for all-concrete monolithic pool pours.

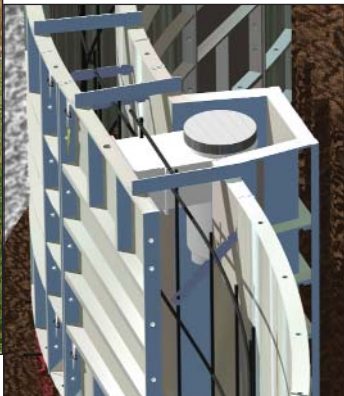

Concrete Placement - Hopper Method

Concrete is placed into the concrete forms at a 3" slump starting in the deep end walls. Once deep end walls are filled with concrete, the walls are vibrated; this allows concrete to flow under interior forms. Next placement continues in the deep end of the pool, stacking concrete until both wall and floor come together achieving monolithic pour.



Concrete Placement - Shear Wall Method



Concrete placement using the shear wall method achieves the monolithic concrete shell with a full depth vertical wall in the deep end.



Finishing Concrete

Finishing of concrete floors begins while the placement of walls continues.

Once concrete is cured to minimal strength, remove the forms, break the tie ends. This leaves the pool ready to be plastered, tiled, epoxy painted or finished using other methods.



The Forms





Swim-crete recommends that when using or installing our products that all national and local swimming pool and spa codes along with OSHA guidelines and regulations be followed, and that our products be used exclusively for their specifically intended purposes and uses.

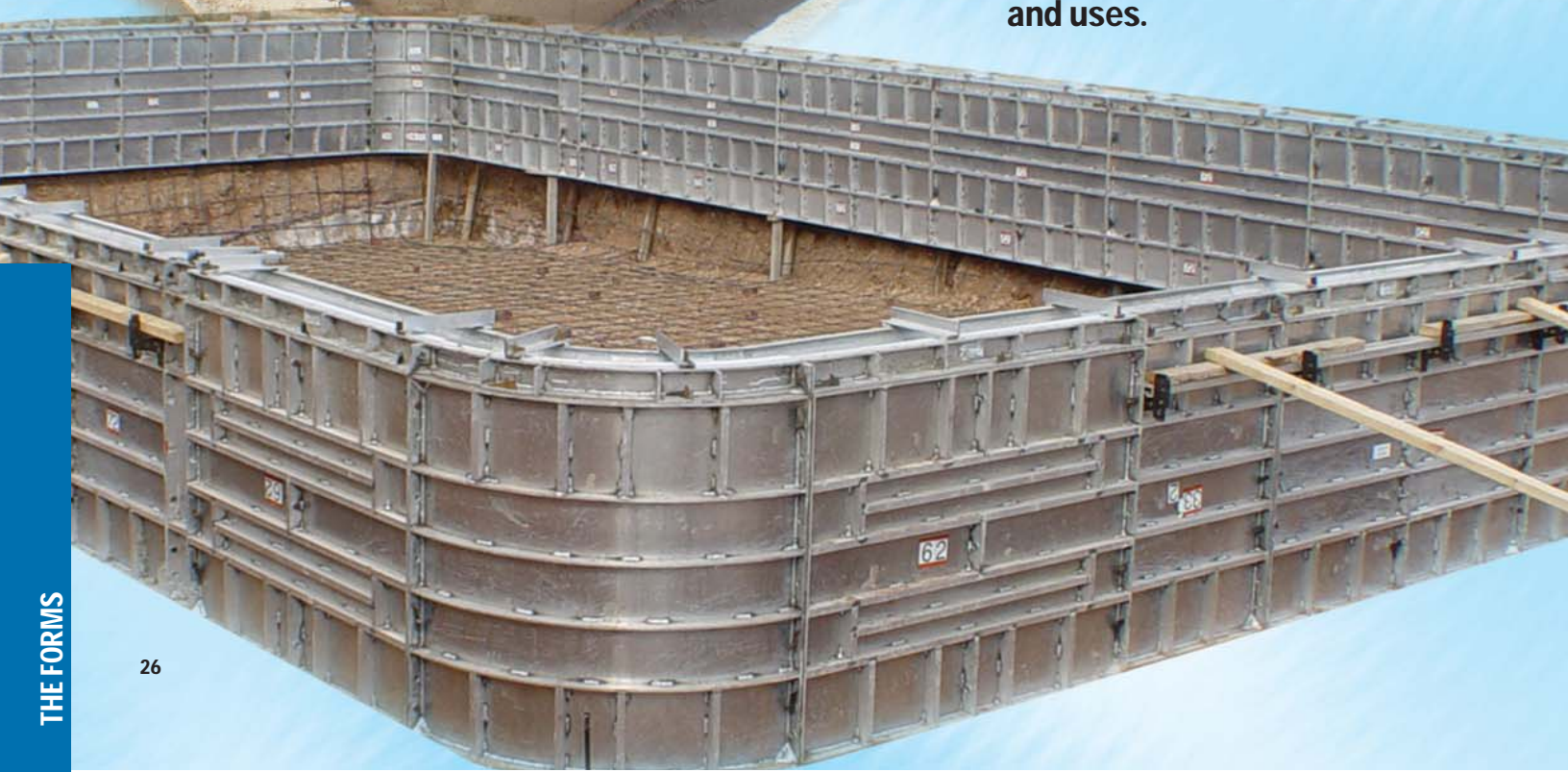

Straight Wall Forms



Imperial English Measurements

Heights

48", 42" (Standard)

Other heights available: 6" - 144"

Lengths

1" - 72"

Weights

72" x 48" weighs 90 lbs

36" x 48" weighs 43 lbs

Metric Measurements

Heights

100cm, 110cm (Standard)

Other heights available: 20cm - 270cm

Lengths

10cm - 150cm

Weights

150cm x 100cm weighs 30 kilos

100cm x 100cm weighs 18.2 kilos



Radius Forms



Radius forms are available in many different radii and are commonly used in conjunction with our straight wall forms.



Imperial English Measurements

- 6" radius corners
- 2' - 32' radius forms
- 10" thick wall

Metric Measurements

- 50cm radius corners
- 50cm - 700cm radius forms
- 20cm radius wall thickness



Corner Forms

Catering to the needs of our customers, we have developed a multitude of corners. Our common corners are the 2' and 6" radius corners. Our diagonal corners normally vary between 7" and 12" depending on the pool dealer preferences. We offer 90° corner as well as 45° and 30° corners used in the Lazy-L and Grecian pools.



2' Radius Corners



45° Corners

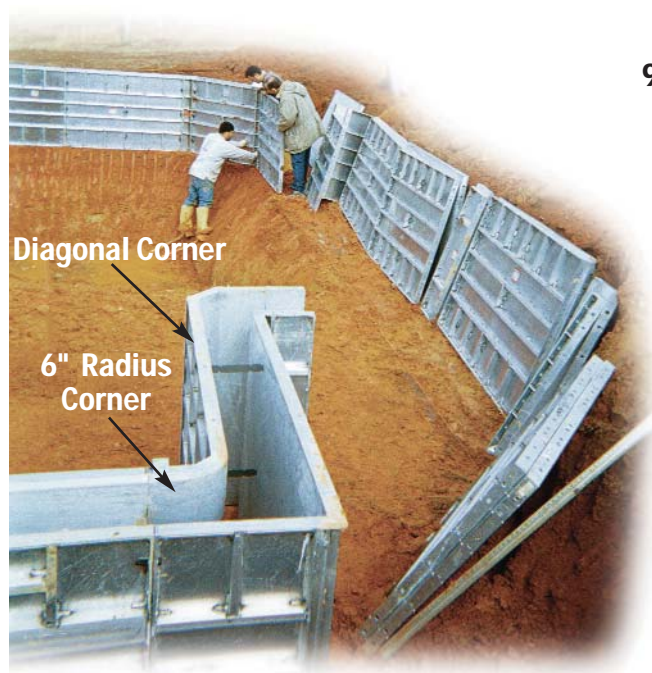

Diagonal Corner

6" Radius Corner

90° Corner

Diagonal Corner

6" Radius Corner

We also offer 3' and 4' radius corners.
Metric corners available.

Skimmer/Pilaster Forms



Note: Always tape the top of the skimmer to prevent concrete leakage

The skimmer can easily be installed when using the one or three piece pilaster forms. Skimmer/pilaster forms are available in straight wall as well as most radius walls.

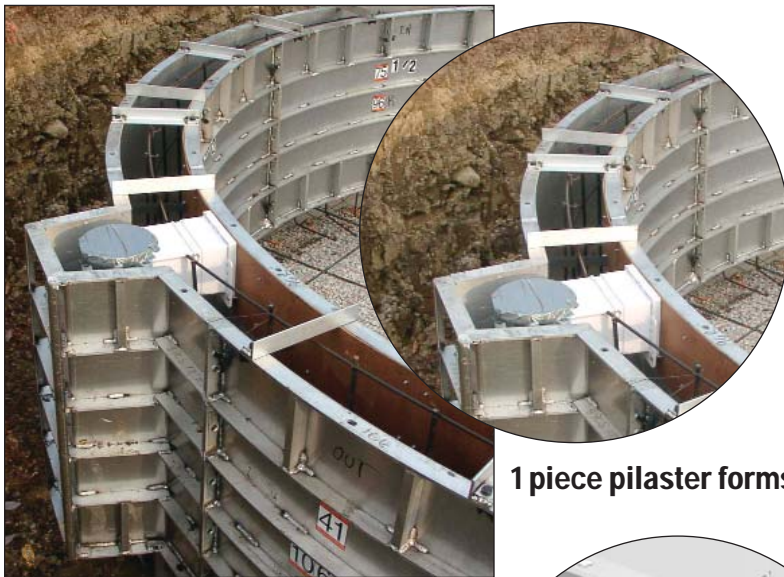

1 piece pilaster forms

Allows for various pilaster sizes utilizing different size fillers.

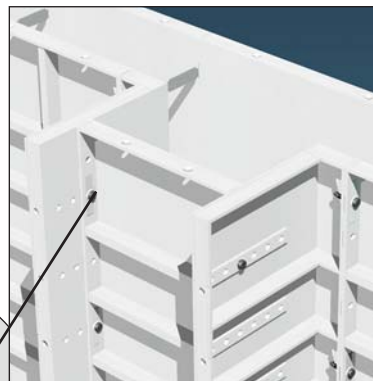

3 piece pilaster forms

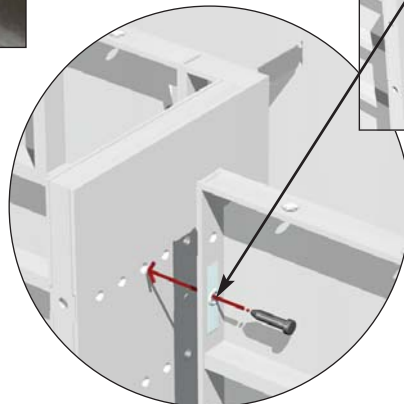

Swimout/Bench Forms

Swim-crete offers a variety of different swimouts. Radius as well as straight wall swimouts are available, fitting the shape of the pool or extending out of the shape for more swim area.

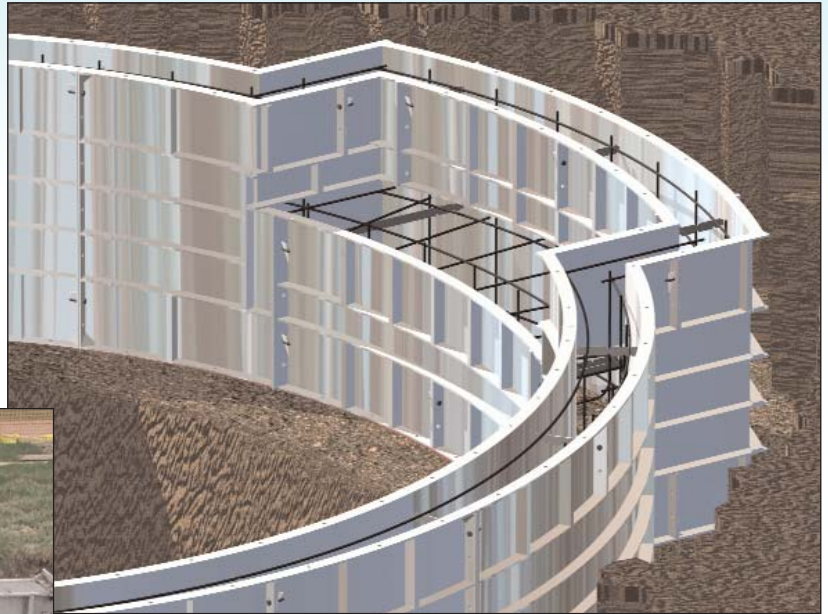

Secondary Pour Bullnose Coping Forms



Bullnose forms in combination with liner track allow for poured concrete coping.

Can achieve a thousand pours or more!

Offset exterior bullnose form produces a 2" offset to receive the concrete deck.



Stackable Raised Wall



A retaining wall can be added simply by stacking forms and placing the concrete at the same time as the pool wall.

Overflow Forms and Channel

These forms allow the overflow and channel to be cast simultaneously with the pool walls.

They also work in conjunction with our straight wall forms as well as some radius forms.



Offset Forms

Form produces a 2" offset ledge to accept stone for cascading/shear wall fountains and elevated retaining walls. This process eliminates the need for costly secondary wall construction.

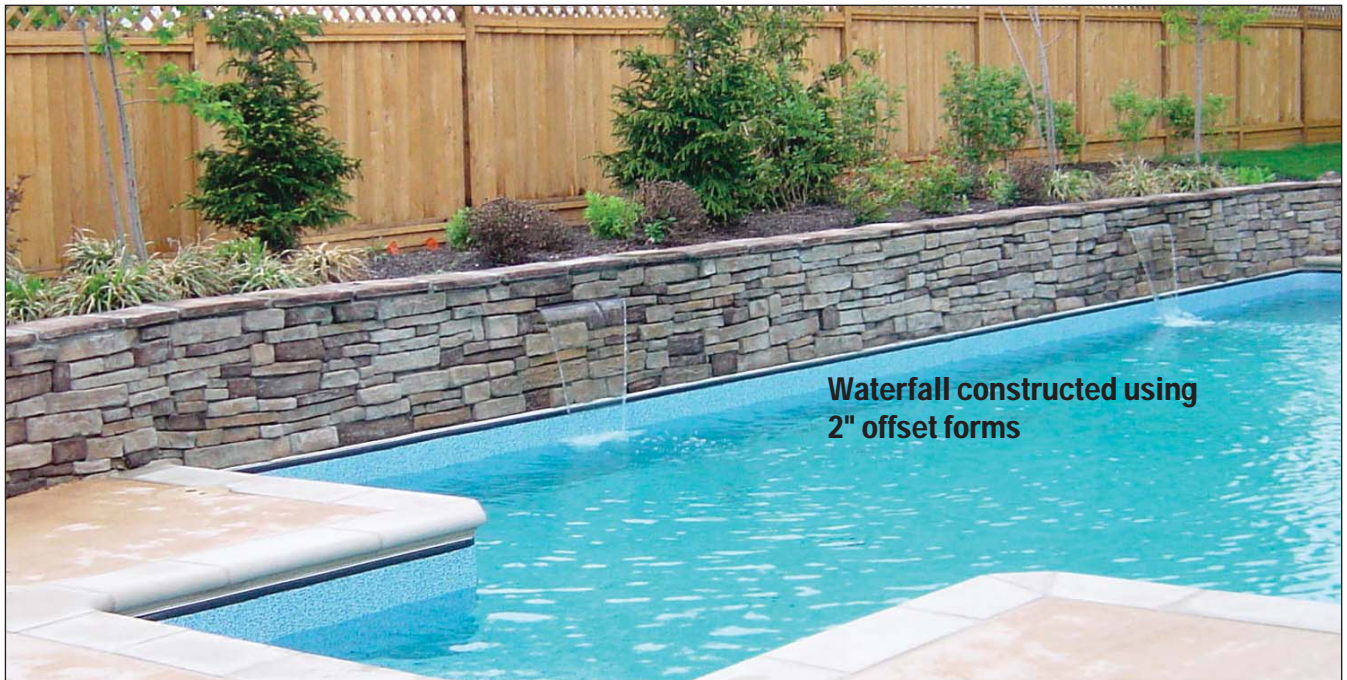

Essential Extras



Adjustable Waler Bracket/Waler Board

The adjustable waler system is attached to the forms on the interior of the pool. Using waler boards ensures the straightness of the wall.



Aluminum Waler Board



Adjustable Steel Waler

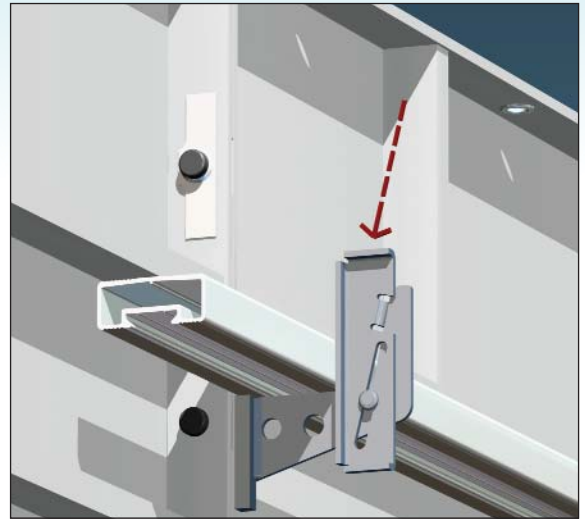

- Engage waler to tighten waler board.

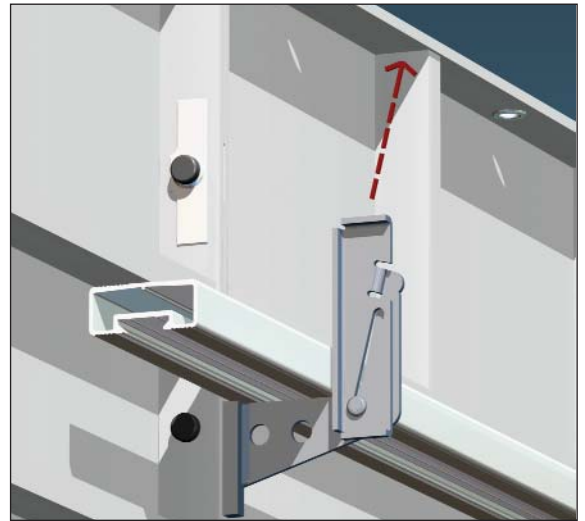

- Disengage to remove waler board.

Standard Pin & Wedge

Round tapered pins have a milled wedge slot. The shank is designed to eliminate pin sag and improve ease of stripping. Pins are made from steel and are heat-treated for long life.



Standard Wall Ties

Swim-crete steel ties are manufactured to meet the requirements of today's various pouring methods. We continually perform quality control testing to ensure that all of our ties yield a minimum pull strength of 7,200#.



STEEL FORM TIE

Breaking ties is accomplished by striking downward or sideways with hammer or utilizing the Swim-crete Tie Breaker Bar.

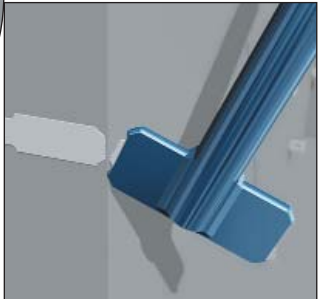
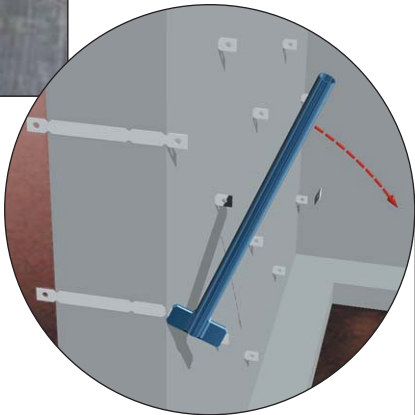

Blockoffs

The blockoff is used for blocking off wall ends. Commonly used in elevated fountain or retaining wall applications.



Leveling System

Leveling jacks attach to the top of the wall, allowing for simple leveling of the pool forms.



Aluminum Wall Brace

Available in 5'3" length
- Ideal for 42" and 48" walls



Tie Twister

Used to tie wire ties quickly and easily. Works with any size wire tie.



Turnbuckles

The turnbuckle allows adjustment without moving brace. Easily attached to either lumber or metal pipe to manipulate wall braces that pin to the form.



Pouring Shovel

Fabricated with lightweight aluminum and made to drag concrete inside forms.



Slide Hammer

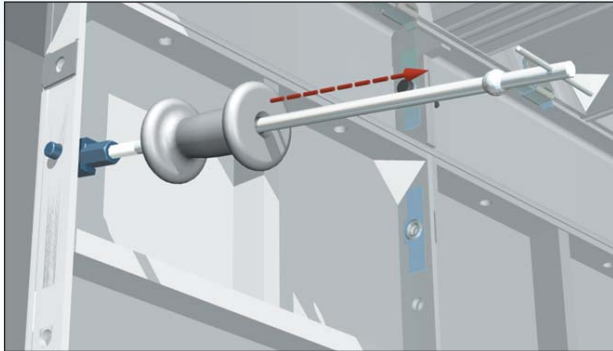

Ideal for removal of step forms.



Parapet Bracket

The Parapet Bracket is used in suspending the formwork on one side of the wall from the opposite side. This is commonly used in all-concrete pool construction.

Parapet Brackets are also available to offset same height forms.



Hottub & Step Parapet Brackets

These parapet brackets maintain exact dimensions.



5 Gallon Spray Tanks



Compact 5 gallon hand tank allows for easy application to forms. Lightweight stainless steel with 4' hose and gun.

- Replacement parts are available

***Spray tanks should not be filled over 2/3 full.**
Both tanks are designed with safety filler caps.

Pouring Board



Lightweight, totally aluminum board constructed with "L" shaped bracket on back that slips over the top of the form. Naturally helps reduce spillage and removal of form oil off forms at discharge locations. Directs uniform flow of concrete during placement.

Standard Chutes w/Flare

Swim-crete smooth flow aluminum chute is durable and lightweight. Our chutes are made of extruded heavy gauge aluminum and reinforced with cross beams and secured attachment chain. The aluminum chute weighs less than 5 lbs. per foot which makes it easy to handle by a single worker.

Flare added for ease of use.

Available sizes: 8' - 26' in 2' increments



Crete-Lease 727 Release Agent

Crete-Lease 727 is a mineral based release agent that has been used for more than 25 years. It applies at low and high ambient temperatures and it exceeds all state and federal VOC regulations.

Basic Use: Crete-Lease 727 permits easy stain-free removal of forms, form liners, pallets, etc. from hardened concrete. It:



Cuts form clean-up time up to 70% when properly applied.

Can reduce bug holes on concrete surfaces.

Does not interfere with adhesion of caulk, architectural coatings, paint, sealers, and curing compounds on cured concrete surfaces when properly applied.

Works superbly on aluminum forms.

Can be applied in sub-freezing or very hot temperatures.

Reduces incidences of skin rash to an absolute minimum.

Can produce both high visual impact (CCS 2) and typical concrete surfaces (CCS 3, CCS 4, CCS 5).



Ready to use - Available in:
5 Gal. Pail
55 Gal. Drum

Even when applying 10 times more than required:

No staining when cured at ambient temp.

Concrete surfaces are not "killed".

Does not cause efflorescence.

Crete-Lease "Break-In" Aluminum Form Conditioner



Available in: 5 Gal. Pail

"Seasons" new aluminum forms before first use with concrete...helps prevent concrete from sticking.

Basic Use: To condition surfaces of new, unused aluminum forms before their first use. Crete-Lease "Break-In" oxidizes the aluminum surface to keep concrete from sticking. It:

Conditions forms even at 45°F.

Is not as messy as "liming".

Removes residual oils.

Is biodegradable.

Step Shapes



Outside Steps

Swim-crete offers numerous sizes, shapes, and styles of our concrete step system.

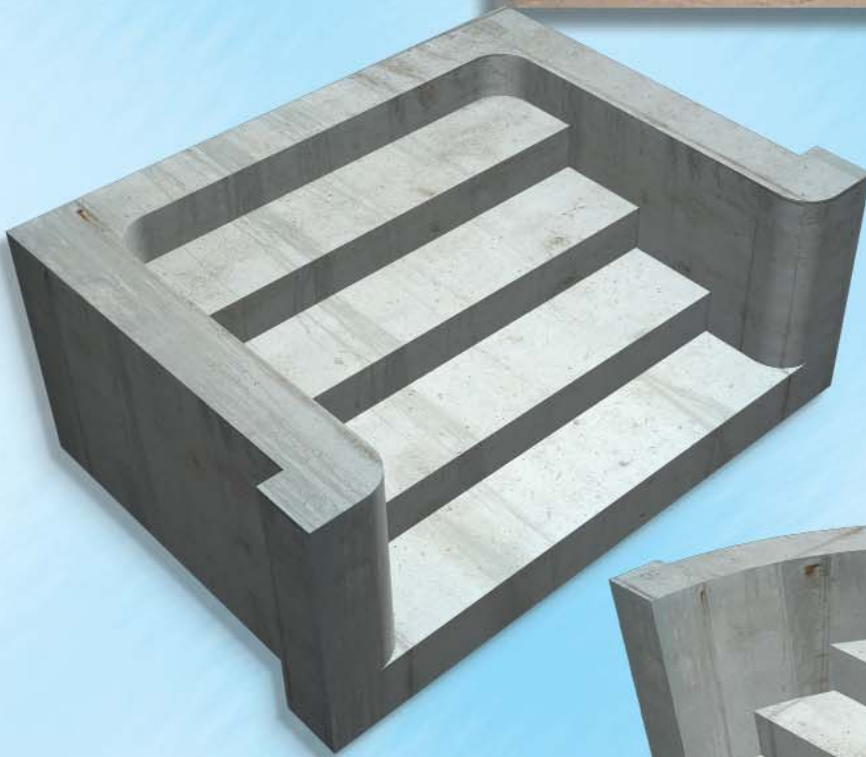

- Manufactured in a variety of widths
- Flush or offset from pool wall
- Corners available:
 - 90°
 - 6" radius
 - Diagonal

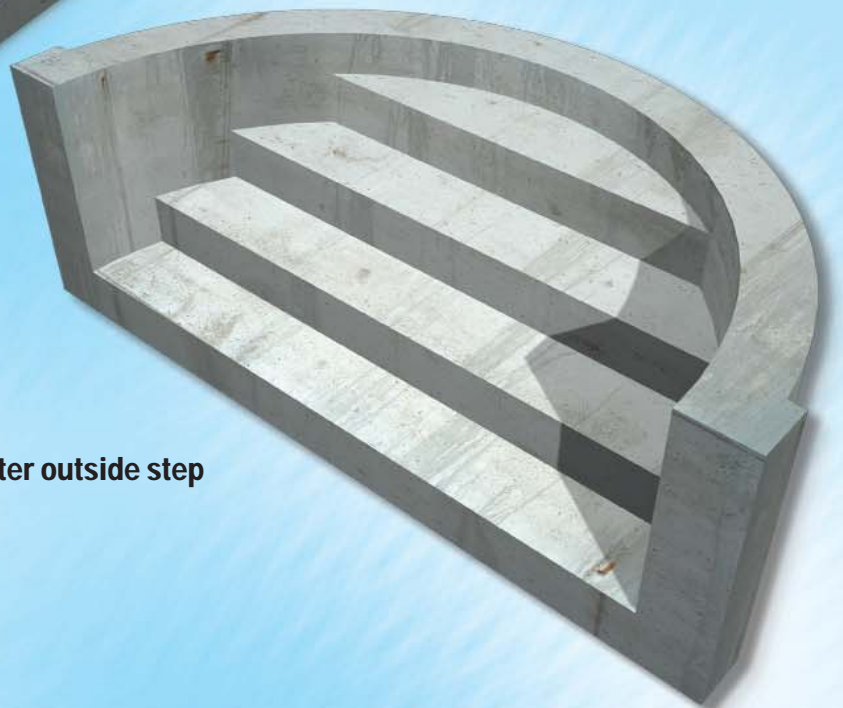

5' diameter outside step

End Steps

The Swim-crete Step System is the most diverse system on the market today!

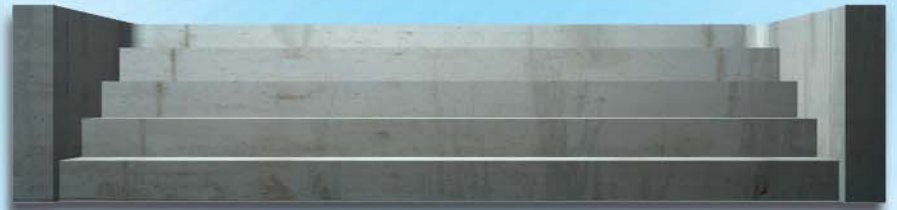
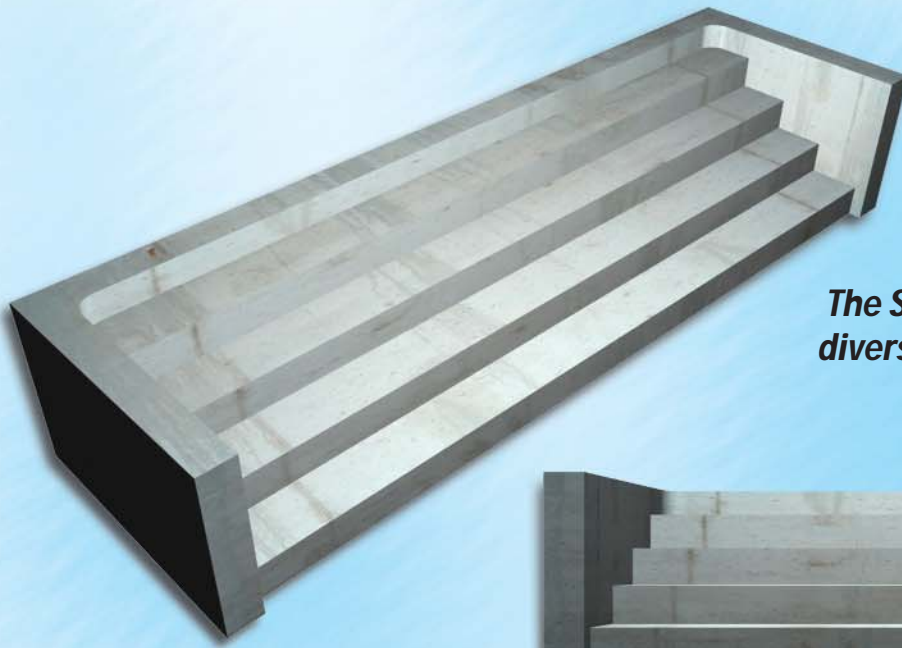

Available for any width of straight wall pool

Straight Corner Steps

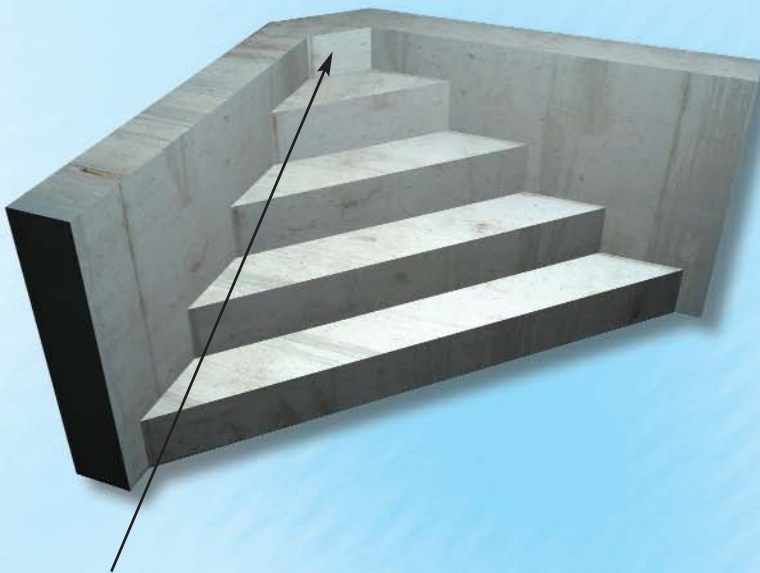

Straight Corner Step with Diagonal Corner



Also available with 6" or 2' Radius Corner



Radius Corner Steps



Radius Corner Step with Diagonal Corner



Radius Corner Step with 6" Radius Corner



Radius Corner Step with 2' Radius Corner

Radius Inside Steps



Manufactured in 6', 7', 8', 9' and 10' Radius

Radius Outside Steps

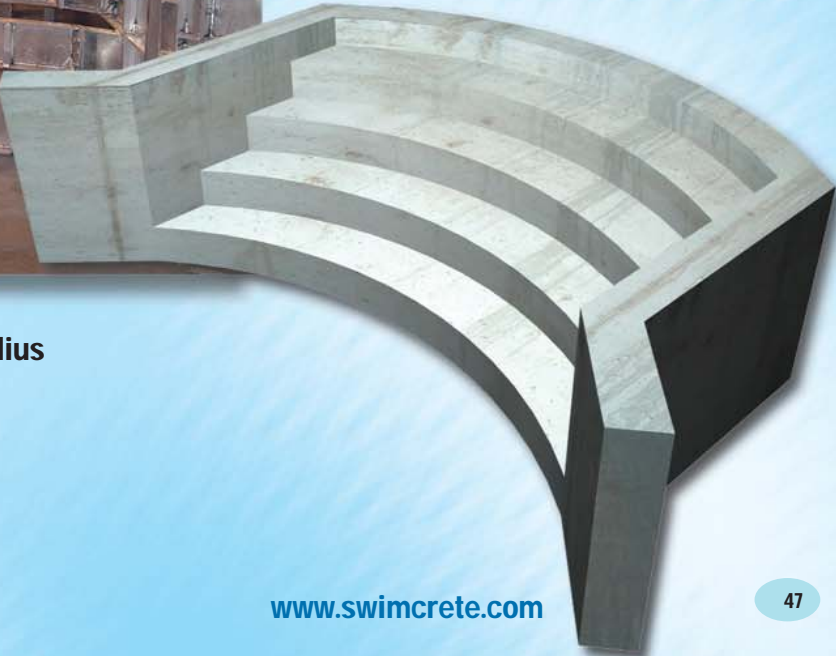

Available in 6', 8', 9' and 10' Radius

Roman End Steps



Available in widths 15' or 4 meter and larger



Pool Shapes



The Swim-crete forming system enables Pool Dealers to design pools in almost any shape and size. This allows the option to choose from traditional geometric shapes like rectangles, grecians and L-shapes, or free form shapes such as mountain lake, kidney and lagoon style pools.

Swim-crete
POOL PRODUCTS

Rectangle with Straight Corner Step and Diagonal Corners



RECTANGLES

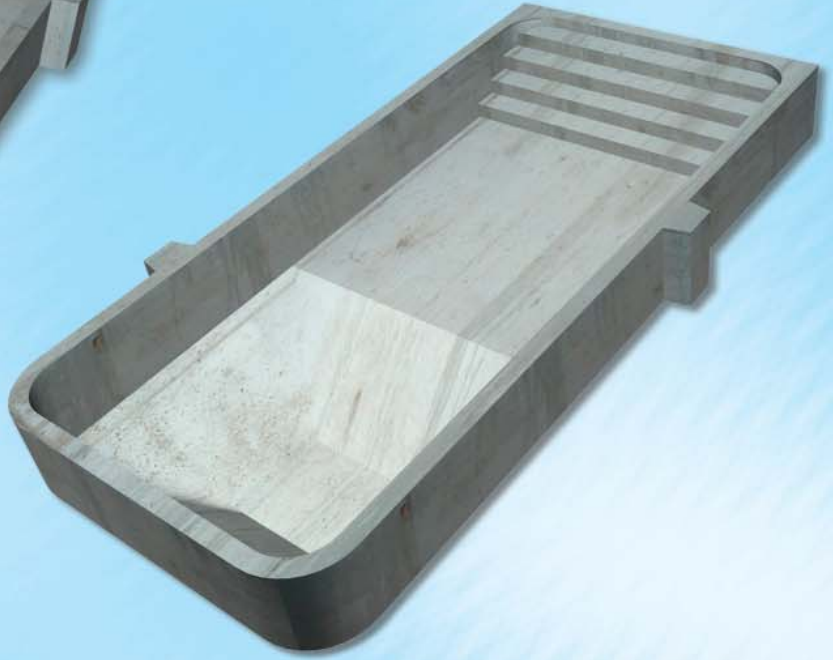

Industry Standard Sizes

16' x 32'

18' x 36'

20' x 40'

Additional English & Metric Sizes Available

Rectangle with 2' Radius End Step and 2' Radius Corners



Rectangle with Roman End Step and Roman End

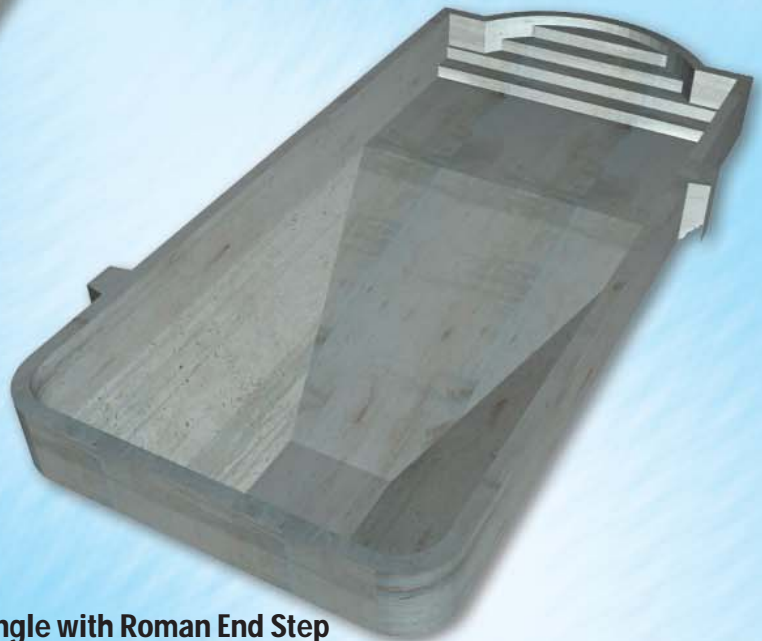

Rectangle with Roman End Step and 2' Radius Corners

**Rectangle with 10' Diameter Outside
Step & 90°.**

RECTANGLES

Industry Standard Sizes

16' x 32'

18' x 36'

20' x 40'

**Additional English &
Metric Sizes Available**

**Rectangle with Outside
Step and 2' Radius Corners**

**Rectangle with Radius Corner
Step and 2' Radius Corners**



GRECIAN ENDS

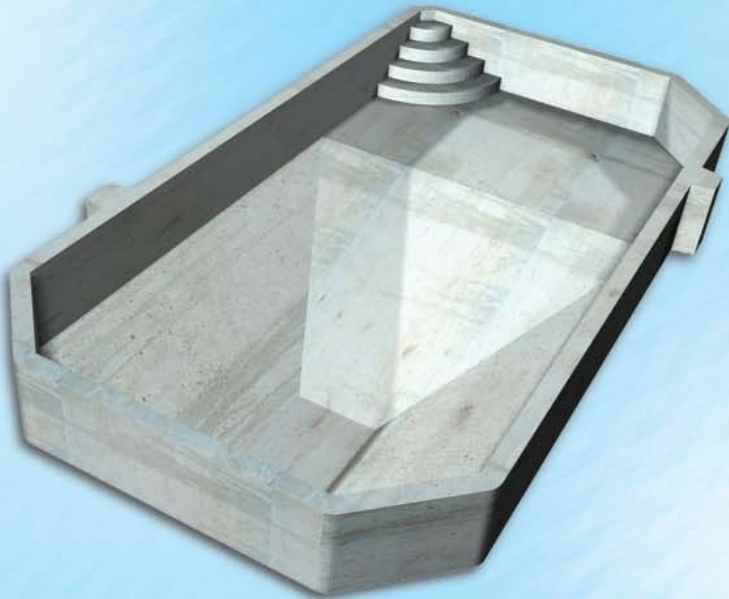

Grecian with Radius Corner Step

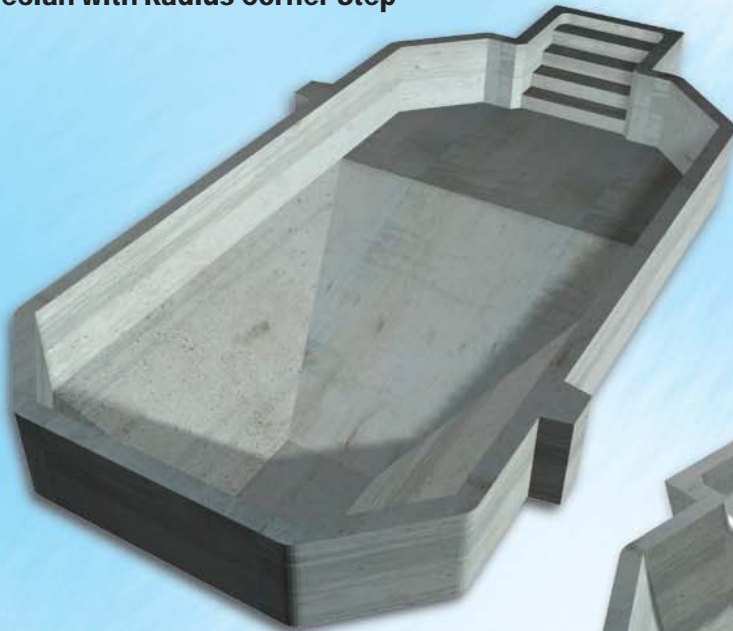

Grecian with Outside Step



Grecian with Swimout

Industry Standard Sizes

16' x 32'

18' x 36'

20' x 40'

**Additional English and
Metric Sizes Available**



**L with Outside Step
and Grecian Corners**

L's



**L with Outside Step
and 2' Radius Corners**

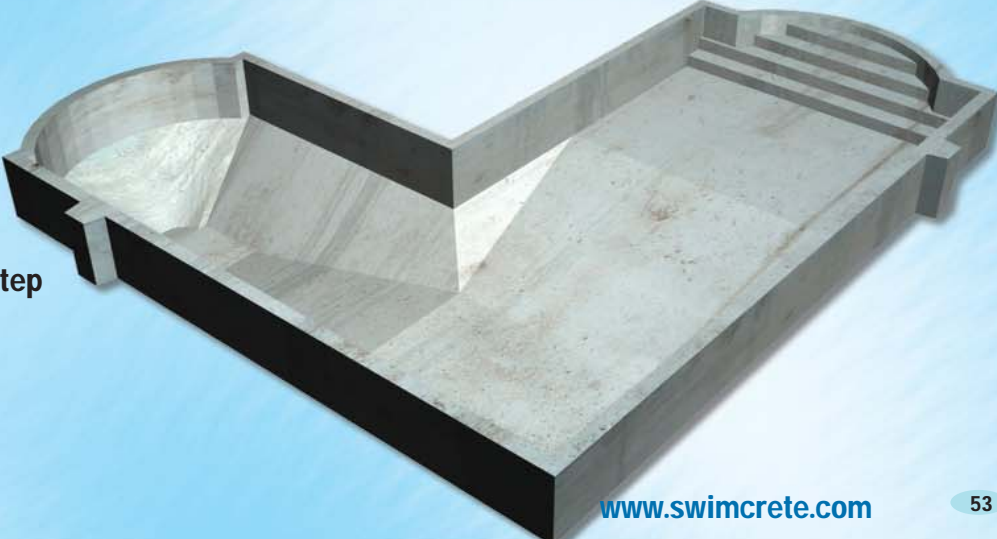

**L with Roman End Step
and Roman End**

L's

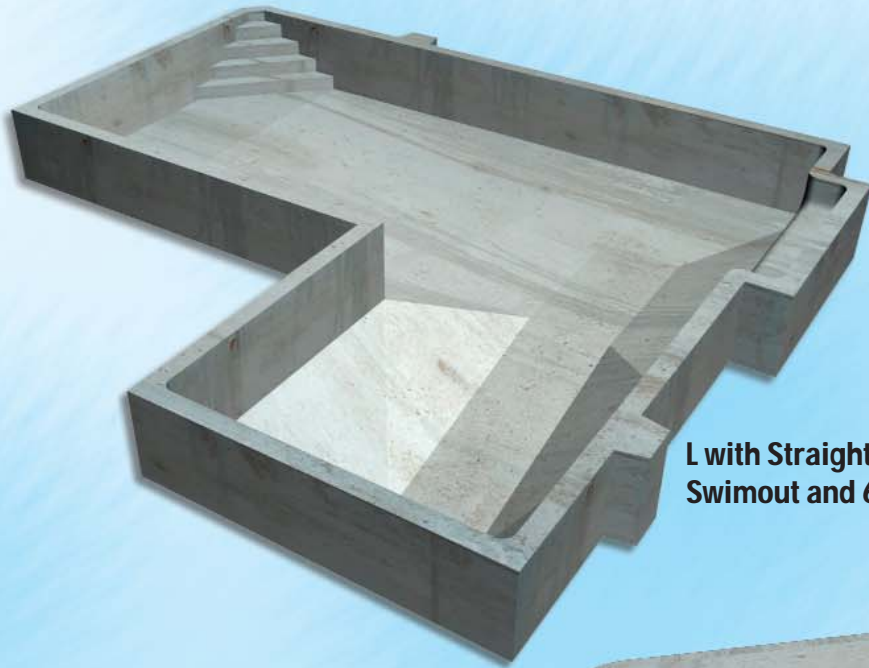

L with Straight Corner Step,
Swimout and 6" Radius Corners

Industry Standard Sizes
16' x 32' - 12' x 12'
18' x 36' - 14' x 14'
20' x 40' - 16' x 16'
**Additional English and Metric
Sizes Available**



L with 2' Radius Corners



L with End Step
and 90° Corners

LAZY L's



Lazy L with Roman End Step and 2' Radius Corners



Lazy L with Outside Step and Diagonal Corners

30° or 45°

Industry Standard Sizes

16' x 32'

18' x 36'

20' x 40'

Additional English and Metric Sizes Available

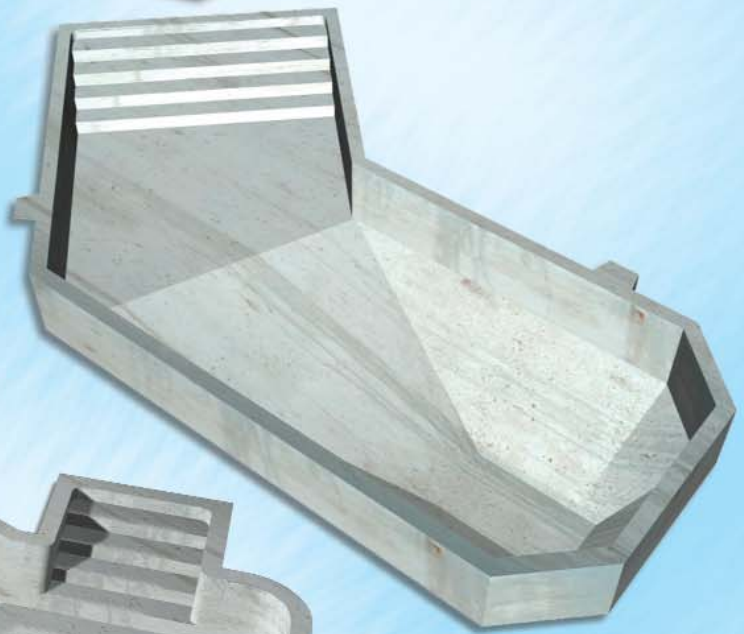

Lazy L with End Step and Grecian End



Lazy L with Outside Step and 2' Radius Corners with corner bench seat

LAZY L's

Lazy L with Outside Step and 6" Radius Corners



Lazy L with Radius Corner Step and 2' Radius Corners

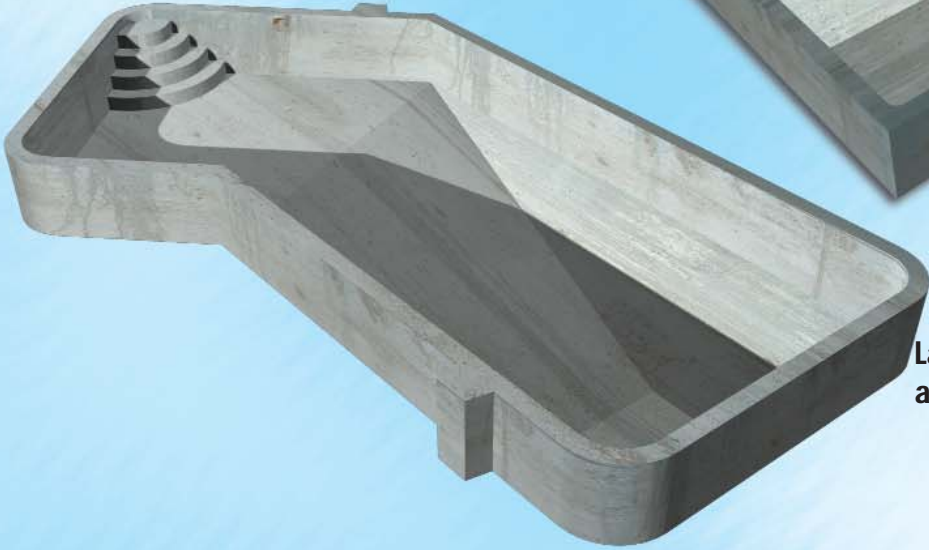

Lazy L with Straight Corner Step and 2' Radius Corners



Lazy L with End Step and 90° Corners





Oval with Radius Outside Step

Industry Standard Sizes

16' x 32'

18' x 36'

20' x 40'

**Additional English and Metric
Sizes Available**

OVALS



Oval with no Step



Oval with Radius Inside Step

KIDNEYS

**Additional Metric Sizes
Available**



3.5 x 7 Meter Kidney
with no step

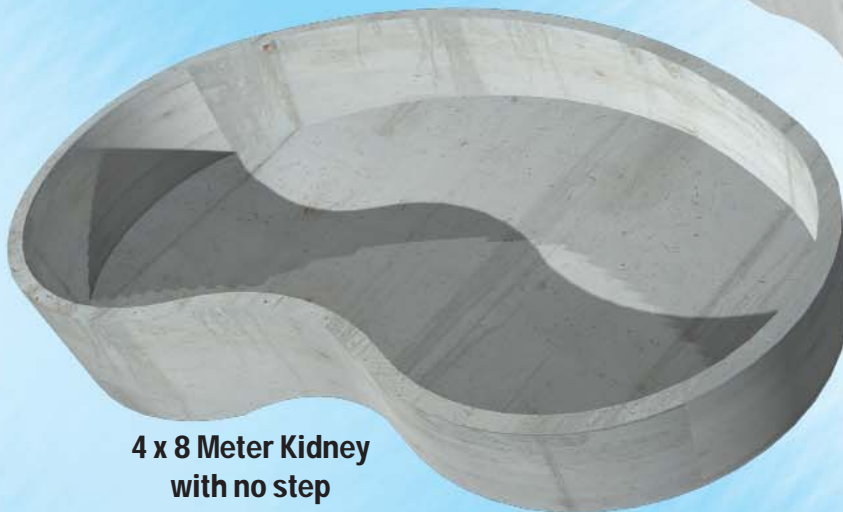

4 x 8 Meter Kidney
with no step

KIDNEYS

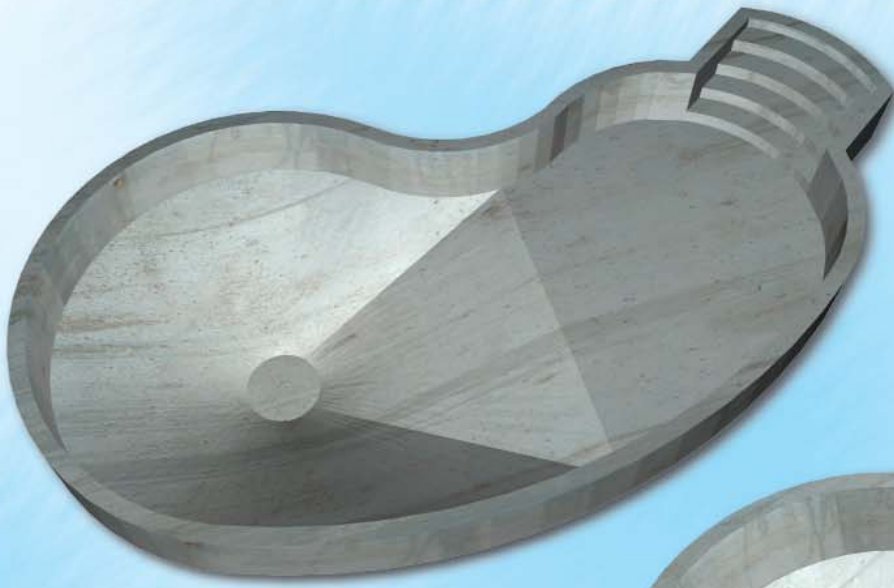

Kidney with Radius Outside Step

Industry Standard Sizes

16' x 32'

18' x 36'

22' x 41'

**Additional English and Metric
Sizes Available**



Kidney with no Step

Kidney with Radius Inside Step



MOUNTAIN LAKES

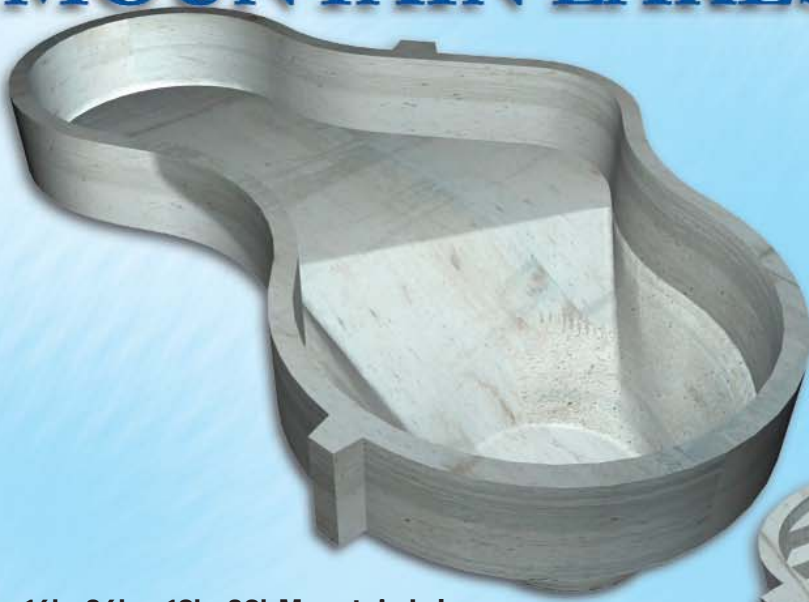

**16' x 36' or 18' x 39' Mountain Lake
with no Step**



**16' x 32' or 18' x 32'
Mountain Lake
with Radius Inside Step**



**20' x 45' Mountain Lake
with Radius Inside Step
and Swimout**

**18' x 40' or 20' x 40' Mountain Lake
with Outside Step and Bench Seat**



**Additional English and
Metric Sizes
Available**

CUSTOM SHAPES

Built to Pool Dealer Designs



Double Hex with Outside Step and Bench



Peanut shape with Radius inside steps



Lazy L with End Step and Spa

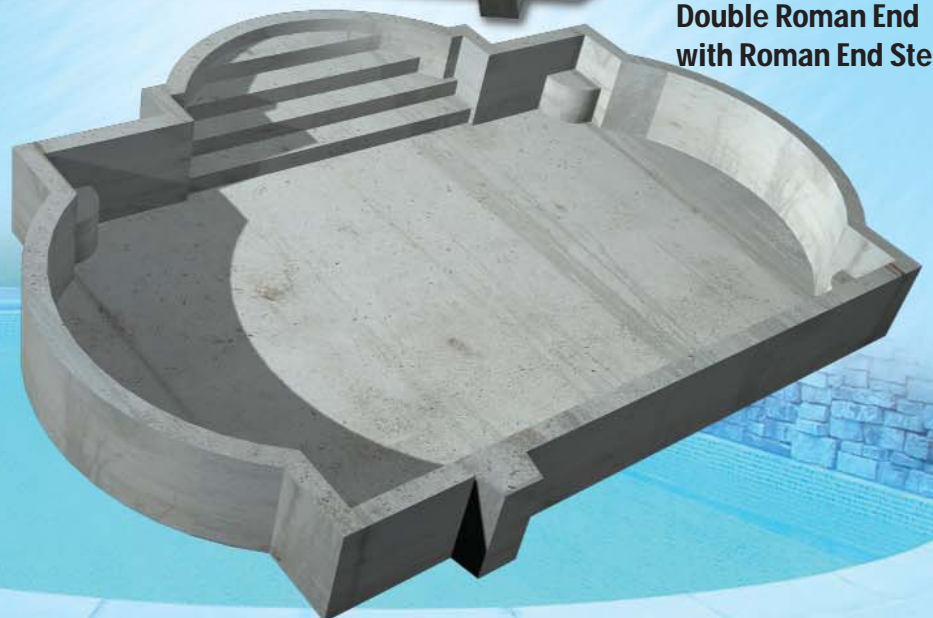

Double Roman End with Roman End Step

SPAS/ HOTTUBS

Rectangle Spa with End step



Square Spa with Seat and Steps



Built to meet
Pool Dealer specifications!

Round Spa with Seat and Steps



SPAS/ HOTTUBS

Round Spa with Inside Steps



Octagon Hot Tub



Aluma-Trac

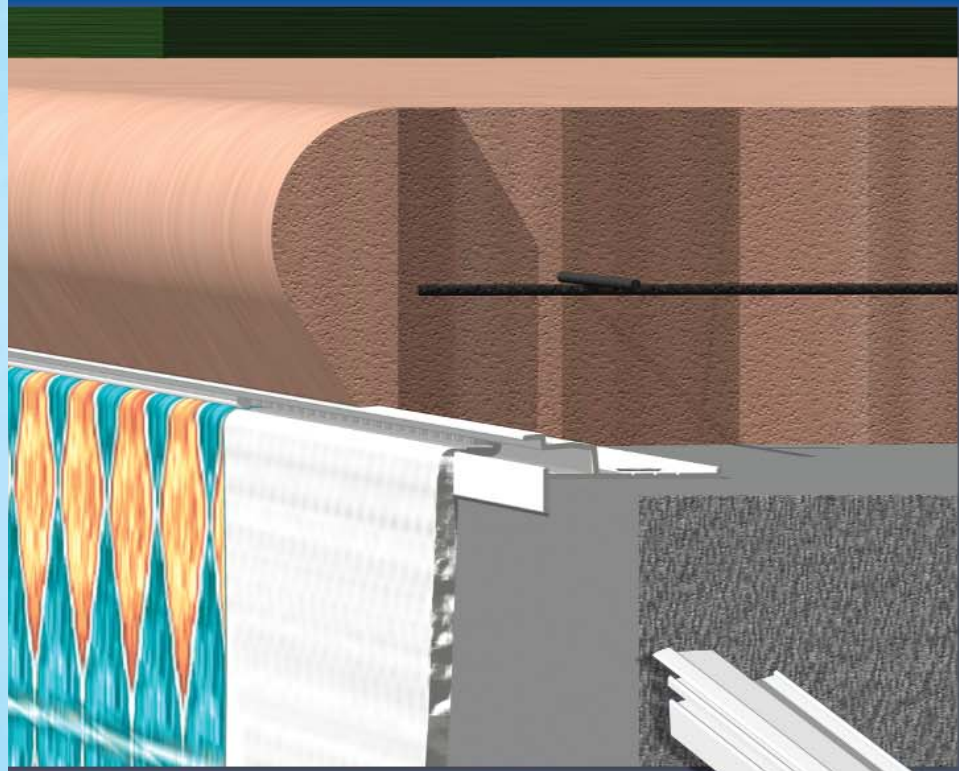

Now you can purchase our Aluma-Trac products online by going to the website www.linertrack.com

*Swim-crete*TM
POOL PRODUCTS

90° Double Aluma-Trac

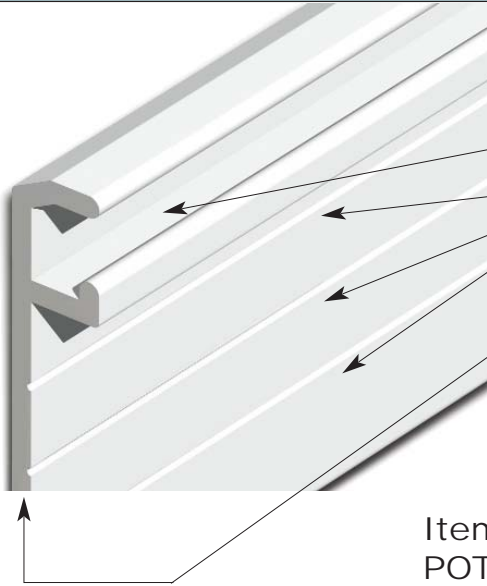

1. Narrow bead receiver brings liner closer to pool wall.
2. Three areas for easier mounting when drilling screws or nails to pool wall.
3. Attachment made easier with long mounting flange, can be used on all types of pools.

Item Number
POTV1915096011

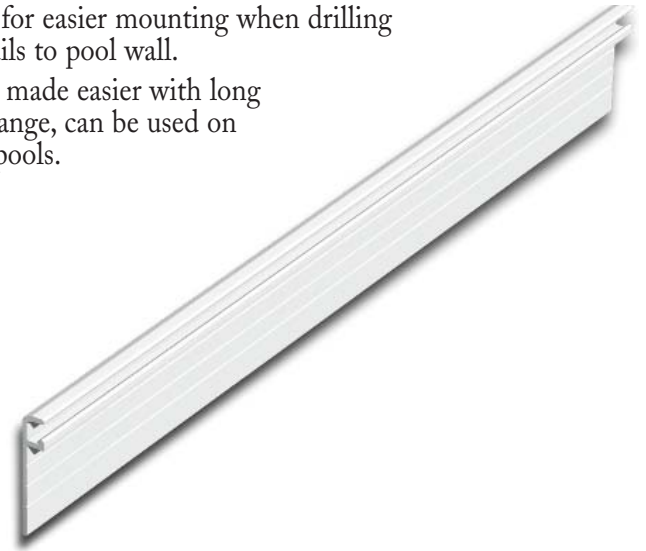

90° Double Aluma-Trac

Item Number
POTV1915096021



2.25"

1. Narrow bead receiver brings liner closer to pool wall.
2. Two areas for easier mounting when drilling screws or nails to pool wall.
3. Attachment made easier with long mounting flange, can be used on all types of pools.



60° Aluma-Trac

Designed to eliminate any gaps between the coping and the liner, while reducing any unwanted space under the pool coping.

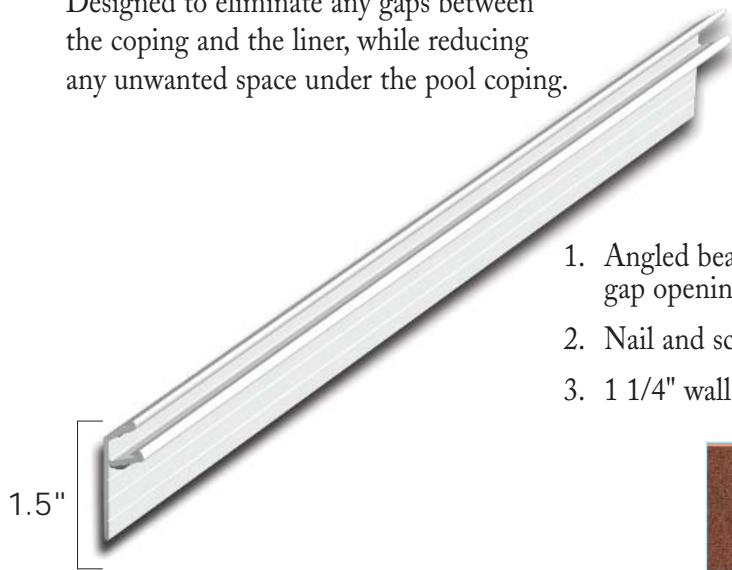

Item Number
POTV1615096011

1. Angled bead receiver to reduce gap opening under coping
2. Nail and screw area
3. 1 1/4" wall attachment area

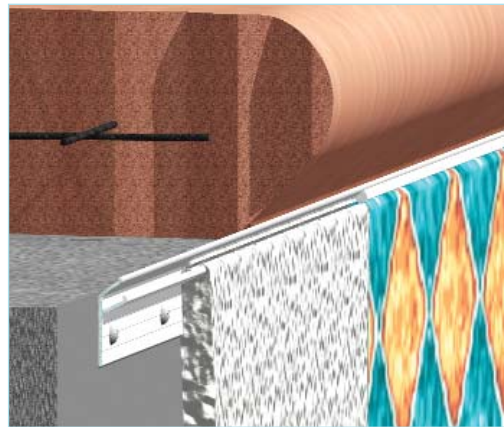

60° Aluma-Trac

1 1/4" Aluma-Trac

Item Number
POTH1125096011

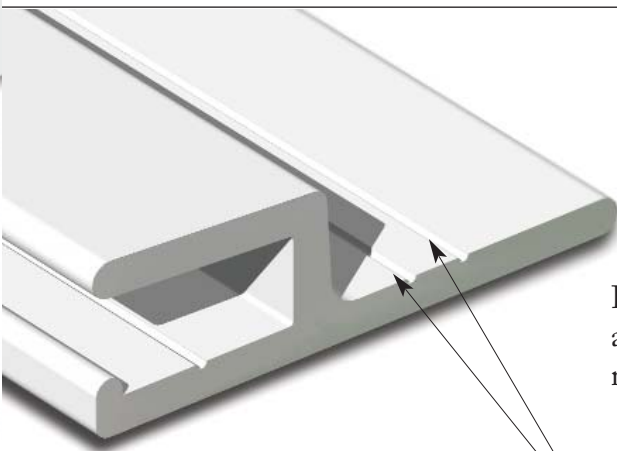

For builders who prefer a narrower profile and do not require vertical alignment.

Two areas for easier mounting when drilling screws or nails to pool wall.



2" Aluma-Trac

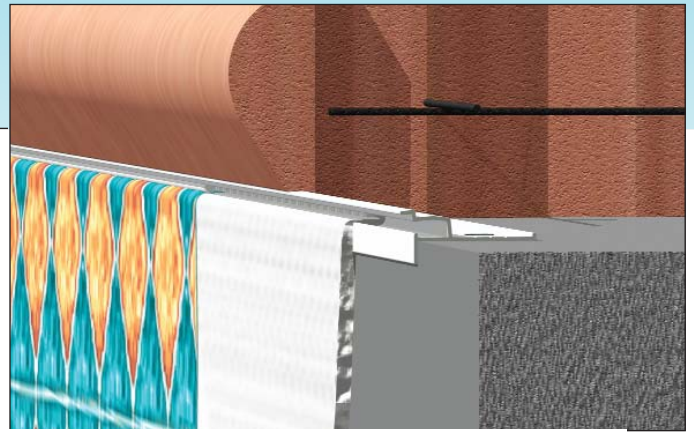
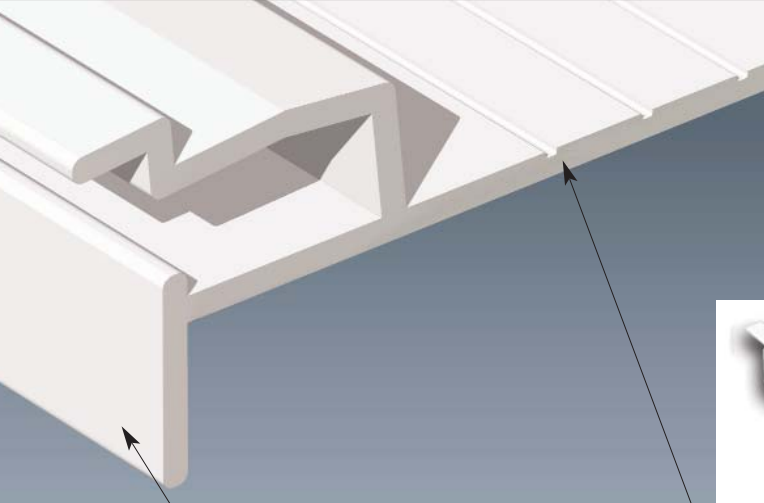

Item Number
 POTH1200096011
 Notched for Radius
 POTH2200096011



1. Wider flange for nail & screw guide area
2. The vertical alignment lip allows the use of double stick tape on cantilever forms to the concrete wall

4" Aluma-Trac

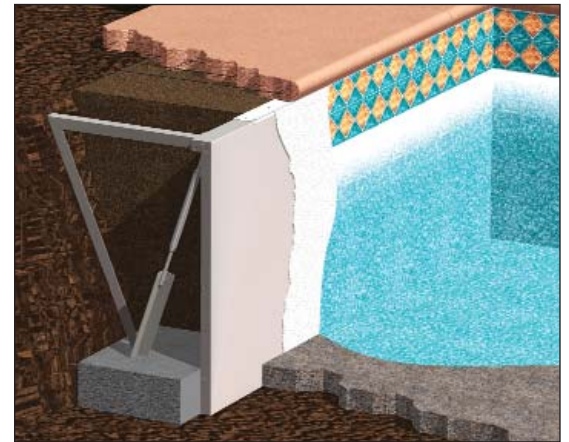
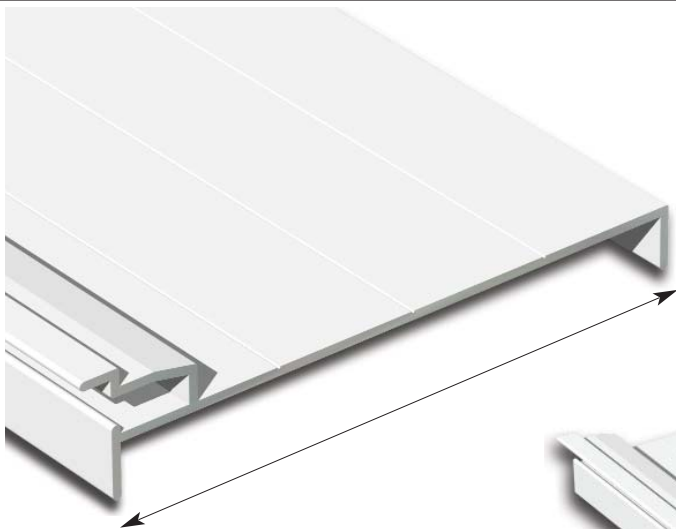

4" Aluma-Trac



1. Front and back lip designed to hold kit walls straight
2. Use with steel and polymer pool kits
3. Works with 4" wide top flange kit

Item Number
 POTH2420096011

1 9/16" Double Aluma-Trac

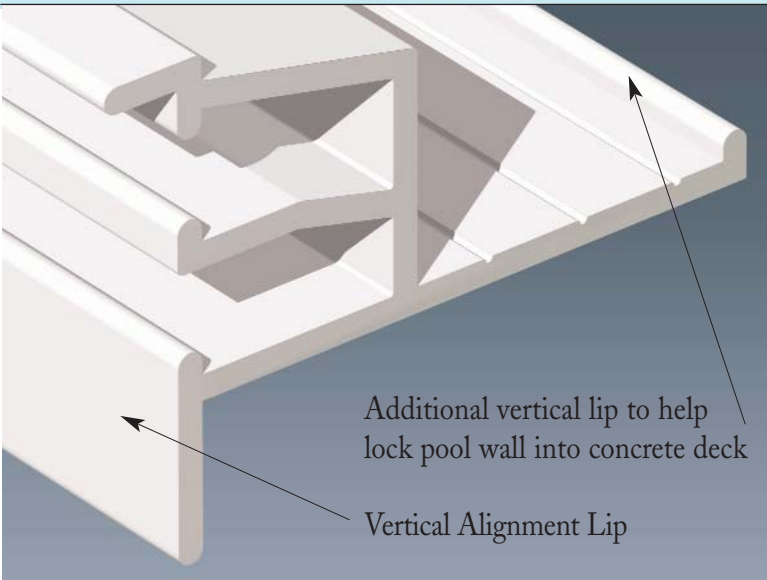

Item Number
POTH11550096021
Notched for Radius
POTH2150096021

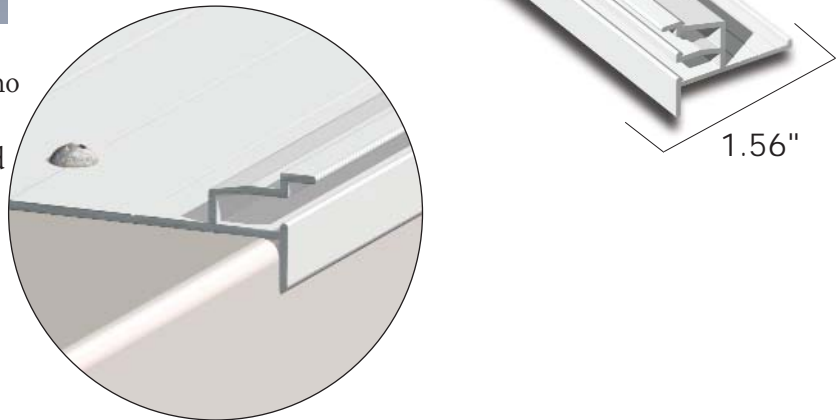

The Double Aluma-Trac is designed for the builder who prefers to install the liner before pouring the deck. The lower receiver bead is for installing the liner bead, and the top track is for locking the cantilever deck forms in place.

Fiber Optic Aluma-Trac

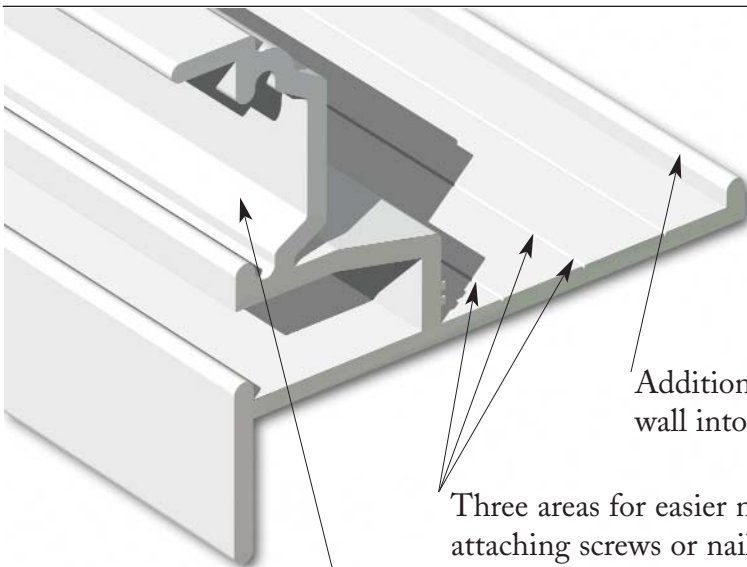

Item Number
POTH1175096031



Receiver that accepts flat fiber-optic lighting

CAD Design Services

Listening to your needs and providing solutions has been the hallmark of our business since day one. From conceptual design through finished product, our engineering department works hard to maximize the benefits of our systems. We design products that meet your requirements and demands, not ours. Special applications and custom design are a challenge, not a problem. That's why we lead the industry in developing solutions through new designs.

As your needs change, we meet them by constant evaluation of our products. Regular consulting with contractors, builders and distributors gives our engineering department first-hand knowledge of our systems in use. This,

combined with on-site training and inspection, ensures the continual improvement of our systems' quality, safety, and cost, continuing in your success.

- Custom Designs
- Innovative Ideas

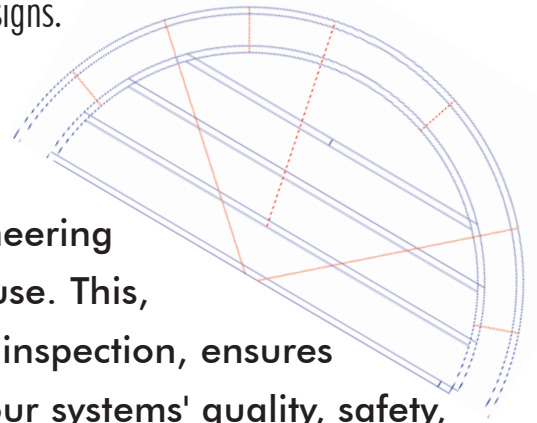

ACTION MARKETING

Action Marketing can offer you professional, impressive, marketing ideas. Our hands-on knowledge of the product helps your end results. Our marketing company will work closely with you to establish your objectives, determining what strategy best meets your needs.

► print

We offer concept, design, writing, stock photography—whatever it takes to relay your message professionally to achieve results. Whether your needs are a flyer, tri-fold brochure, mailer, marketing brochure, training manual, presentation, or catalog, we have what it takes to make it work for you.



► interactivecd's

Interactive CD's, with 720 MB storage space, can be used to create high speed 3-D graphics, panoramic ipix photos, or video. It is a simple technology used to introduce your product and help your prospects get acquainted with you virtually.

► ipixphotography

This new photographic technology uses a specially formed camera lens that takes panoramic 360° photos of rooms, buildings, or landscapes. These amazing photos can then be added to a website or interactive CD to enhance your viewers' virtual experience.

► websitedevelopment

There are many areas in website development in which knowledge and know-how can get you results. Our marketing company has the capabilities of designing your website from start to finish, or working with you on your existing website. We can maximize your exposure by making sure your website rates high in search engines. Furthermore, with a stand alone server specifically for our clients' websites, updates and alterations are much more controllable.



Interactive CD's

3-D Animation

Website Design

Flash Movies

Call today for a quote on your next marketing project, or for a sample of one of our interactive CD's.



Visit these websites to view our work!

913-593-3449



www.swimcrete.com



www.prestigepools.biz



www.securitybuildinggroup.com



www.decoproducts.com



www.poolsareus.net



www.cimbras.com.mx

www.swimcrete.com

Financial Services

Aluminum Forms Capital Source knows and understands the concrete forming business. They have developed a number of leasing plans and provided financing for numerous contractors - from established companies to start-up businesses, and they're easy to work with. That's why Swim-crete Pool Products, has formed an exclusive working arrangement with Aluminum Forms Capital Source.

Think about it. . .With a nominal down payment and minimal monthly payments you can start pouring immediately with state-of-the art aluminum pool forms from Swim-crete. Typical lease terms range from two to five years and with the variety of plans available, one is sure to be right for you.

Compare the one time investment you make with aluminum pool forms to the continuous replacement costs you have with conventional pool forming systems. When you get right down to it, leasing Swim-crete forms through Aluminum Forms Capital Source makes a lot of sense.

If you'd like further information about the advantages of leasing or would like to discuss your individual requirements, call today.

ONE EASY FORM. . .

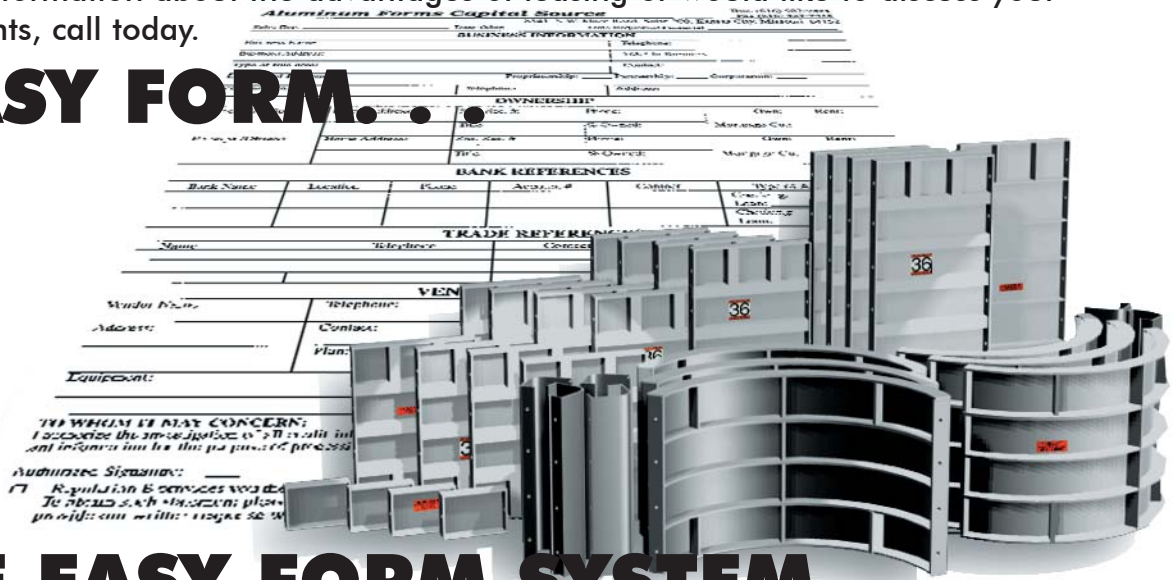

. . .ONE EASY FORM SYSTEM

A.F.C.S.

Aluminum Forms Capital Source

A division of Security Leasing Services, Inc.

816-587-3400 800-467-3111

8341 NW Mace Road, Suite 200

Kansas City, MO 64152

www.slsfinancial.com

www.slsfinancial.com



Construction and pool pictures are provided by these following companies:

American Pools
Haysville, KS

Atlas Pools
Doraville, GA

Commercial Pools
Columbus, OH

Holiday Pools, Inc.
Eugene, OR

Aqua Blue
Taylors, SC

Kimberlane Pool & Spas
Athens, GA

Poolside, Inc.
North Yarmouth, ME

Prestige Pools
Raleigh, NC

Perez Marina Group
Vallencia, Spain

Crystal Construction Corp.
Kingston, MA

Poolside
Traverse City, MI

Skordis Hydrodynamics
Paphos, Cyprus

Pamlico Pools
Milledgeville, GA

Swim King Pools
Long Island, NY

Midstate Pools
Dublin, GA



Wall-Ties & Forms, Inc.

4000 Bonner Industrial Drive Shawnee, Kansas 66226 USA

Telephone: (913) 441-0073 Fax: (913) 441-0076

Toll Free: (800) 444-9692

Credit Application

To induce Wall-Ties & Forms, Inc. (Seller) to permit _____ (Buyer) to purchase goods on credit (open account), Buyer represents and warrants that the following information is true and correct and agrees that Seller may rely upon the same as continuing to be true until notified in writing to the contrary by Buyer: (Fill out completely and, if faxed, please forward original.)

Firm Name _____ Phone No. _____

Office Address _____ Fax No. _____

City _____ Zip Code _____

Mailing Address _____ Type of Business _____

City _____ Zip Code _____

Name of Parent Company if subsidiary _____ Contractor's License No. _____

License in what name. _____ e-mail: _____

Operating as a Corporation Partnership Limited Partnership Individual State of Incorporation or Organization: _____

Bank _____ Branch _____ Phone No _____

Address _____ Checking Account No. _____

In business since _____

Owner or Officer _____ Title _____ Home Phone No. _____

Residence Address _____ Social Security No. _____

Owner or Officer _____ Title _____ Home Phone No. _____

Residence Address _____ Social Security No. _____

Owner or Officer _____ Title _____ Home Phone No. _____

Residence Address _____ Social Security No. _____

Continued on reverse side

References: Please list your current major suppliers (at least three). Give only names of those you buy from on open account. Please do not list subcontractors or revolving credit accounts. For maximum credit, please include your most recent financial statement.

Name	Address	Phone No.	Account No.
1. _____	_____	_____	_____
2. _____	_____	_____	_____
3. _____	_____	_____	_____
4. _____	_____	_____	_____
5. _____	_____	_____	_____

Buyer certifies that the above information is true and correct and agrees to pay for all goods purchased in compliance with the terms of the Seller. Unless otherwise agreed to in writing, said terms are that all goods are to be paid in full 30 calendar days after the invoice date. If default be made in payment when due, the entire outstanding account balance, plus interest at the rate of 1.5% per month (18% per annum thereon, together with reasonable attorney's fee and all costs of collection that Seller may reasonably incur in the enforcement of the obligation. Seller and Buyer agrees that this contract is entered into at Shawnee, Kansas. Buyer expressly consents to venue, at Seller's option, exclusively in the District Court of Johnson County, Kansas. Buyer authorizes Seller to investigate from time to time Buyer's credit background through credit reporting agencies and references listed herein, and for all references to release any and all information. Buyer releases Seller from all liabilities resulting from any information released or obtained. Buyer acknowledges that Seller is under no obligation to sell goods to Buyer on open account or otherwise and such sales are at Seller's sole discretion.

FULL NAME OF COMPANY

SIGNATURE

DATE

NAME AND TITLE

CONTINUING PERSONAL GUARANTEE
(IF A CORPORATION IS APPLYING FOR CREDIT, THIS GUARANTEE MUST BE SIGNED BY A CORPORATE OFFICER(S).)

For and in consideration of selling any goods or materials to the above Buyer on account, or otherwise, by Walls-Ties & Forms, Inc., (Seller) I/We hereby, jointly and severally, absolutely and unconditionally guarantee the credit account, debt or obligation of the above named Buyer. This is a continuing guarantee and shall continue so long as credit is extended or the account, debt or obligation is open. I/We expressly waive notice of default, diligence, resort to security, any obligation to proceed first against debtor or any other guarantor, and joinder of debtor or this guarantee and agree that in the event of litigation, suit may be brought in the District Court of Johnson County, Kansas at Seller's option. I acknowledge that this guarantee is binding upon me/us personally regardless of any corporate or other title I/we may affix or write next to my/our name(s) and/or signature(s).

Dated this _____ day of _____ 200_____

GUARANTOR SIGNATURE / ALSO PRINT

The signature on this Credit Application, if transmitted by facsimile machine, will be acceptable and binding as if it were in the original.

GUARANTOR SIGNATURE / ALSO PRINT

Discover the ultimate in Marketing Technology with this Interactive CD designed by Action Marketing.



If CD is missing please call 800-444-9692, we will gladly send a replacement copy.

Swim-crete[™]
POOL PRODUCTS

Swim-crete[®]
POOL PRODUCTS

Vol. 2

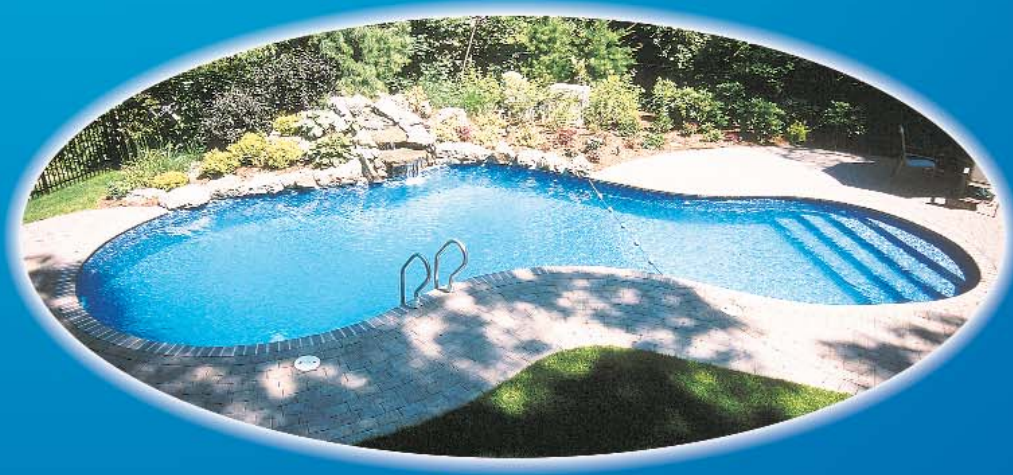

www.swimcrete.com

A DIVISION OF



WALL-TIES & FORMS, INC.

Swim-crete Pool Products • 4000 Bonner Industrial Drive • Shawnee, KS 66226

Tel: (800) 444-9692 • (913) 441-0073 • Fax: (913) 441-0076